

SIMPLEX covers

NEW

Enclosure versions

Bulkhead mount housings with new **SELF-CLOSING** covers ensure IP65 protection rating (according to EN 60529) when mated and locked with the closing lever, or IP44 protection rating when not mated and not locked with lever.

Characteristics of materials used:

- › Made of die cast aluminium alloy.
- › With epoxy-polyester powder coating.
- › Gaskets in anti-aging, oil-resistant, grease-resistant and fuel-resistant vinyl nitrile elastomer.
- › Locking device in stainless steel.
- › Self-closing covers in self-extinguishing thermoplastic material reinforced with glass fibres, UL approved.

Houseable inserts.

The enclosures series can be used with inserts:

- | | |
|-----------------------|--|
| › CD | 40, 64 poles |
| › CT, CTS (10A) | 40, 64 poles |
| › CDD | 24, 42, 72, 108 poles |
| › CDS | 9, 18, 27, 42 poles |
| › CQE | 10, 18, 32, 46 poles |
| › CQEE | 40, 64 poles |
| › CSH | 6, 10, 16, 24 poles |
| › CCE | 6, 10, 16, 24 poles |
| › CNE, CSE | 6, 10, 16, 24 poles |
| › CSS | 6, 10, 16, 24 poles |
| › CT, CTE, CTSE (16A) | 6, 10, 16, 24 poles |
| › CMCE | 3+2 (aux), 6+2 (aux), 10+2 (aux) poles |
| › CME | 3+2 (aux), 6+2 (aux) poles |
| › CMSH | 3+2 (aux), 6+2 (aux), 10+2 (aux) poles |
| › CP | 6 poles |
| › CX | 8/24, 6/36, 12/2, 4/0, 4/2, 4/8, 6/6 poles |
| › MIXO frame | 2, 3, 4, 6 modules. |

SELF-CLOSING





inserts:	page:
CDD 24 poles + ⊕	67
CDS 9 poles + ⊕	78
CSH 6 poles + ⊕	91
CNE, CSE 6 poles + ⊕	104
CCE 6 poles + ⊕	110
CSS 6 poles + ⊕	122
CT, CTSE (16A) *) ... 6 poles + ⊕	130
CQE 10 poles + ⊕	138
MIXO 2 modules	179 - 215

*) can be used only in bulkhead mounting housings

insert centre distance:
44 x 27 mm

bulkhead mounting housings
with single lever



lever in
stainless
steel

NEW

description

part No.

with lever and cover in plastic, size "44.27"

CVI 06 LSP

panel cut-out for bulkhead mounting housings in mm

dimensions in mm

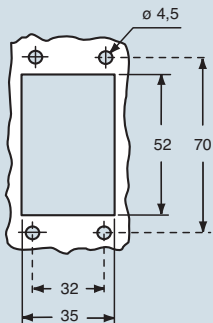

CVI LSP

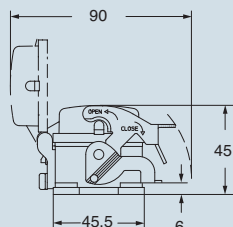
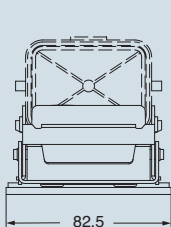

NB:
The enclosures ensure IP65 protection rating when mated and locked with the closing lever, or IP44 protection when not mated and locked with lever.

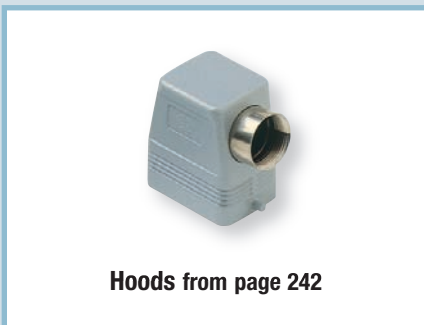

dimensions shown are not binding
and may be changed without notice

SIMPLEX - size 44.27



inserts:	page:
CDD 42 poles + ⊕	69
CDS 18 poles + ⊕	79
CSH 10 poles + ⊕	92
CNE, CSE 10 poles + ⊕	105
CCE 10 poles + ⊕	111
CSS 10 poles + ⊕	123
CT, CTSE (16A) * .. 10 poles + ⊕	131
CQE 18 poles + ⊕	139
CMCE 3+2 (aux) poles + ⊕	148
CMSH 3+2 (aux) poles + ⊕	149
CX 8/24 poles + ⊕	169
MIXO 3 modules	179 - 215

*) can be used only in bulkhead mounting housings

insert centre distance:
57 x 27 mm

bulkhead mounting housings with single lever



lever in stainless steel

NEW

description	part No.
-------------	----------

with lever and cover in plastic, size "57.27"	CVI 10 LSP
---	-------------------

panel cut-out for bulkhead mounting housings in mm	dimensions in mm
--	------------------

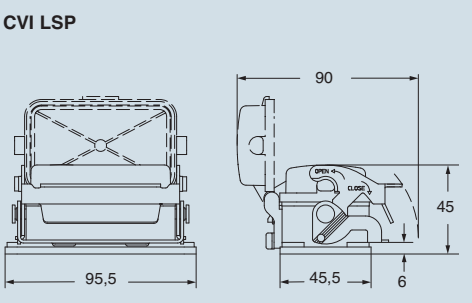
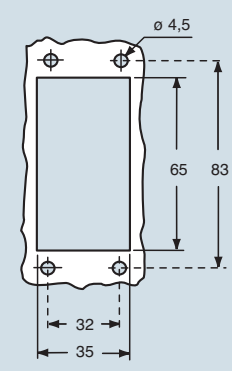

NB:
The enclosures ensure IP65 protection rating when mated and locked with the closing lever, or IP44 protection when not mated and locked with lever.



dimensions shown are not binding and may be changed without notice

SIMPLEX - size 57.27



inserts:		page:
CD	40 poles + ⊕	57
CT, CTS (10A) *)	40 poles + ⊕	64
CDD	72 poles + ⊕	70
CDS	27 poles + ⊕	80
CSH	16 poles + ⊕	93
CNE, CSE	16 poles + ⊕	106
CCE	16 poles + ⊕	112
CSS	16 poles + ⊕	124
CT, CTSE (16A) *) ..	16 poles + ⊕	132
CQE	32 poles + ⊕	140
CQEE	40 poles + ⊕	146
CMCE	6+2 (aux) poles + ⊕	150
CMSH	6+2 (aux) poles + ⊕	151
CP	6 poles + ⊕	162
CX	6/36 and 12/2 poles + ⊕	170-171
CX	4/0 and 4/2 poles + ⊕	172
MIXO	4 modules	179-215

*) can be used only in bulkhead mounting housings

insert centre distance: 77,5 x 27 mm

bulkhead mounting housings with single lever

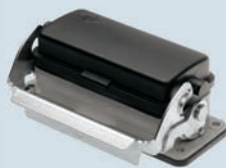

lever in stainless steel

NEW

description	part No.
-------------	----------

with lever and cover in plastic, size "77.27"

CVI 16 LSP

panel cut-out for bulkhead mounting housings in mm

dimensions in mm

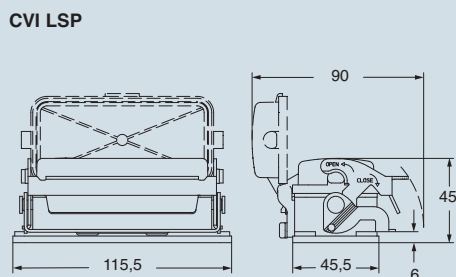
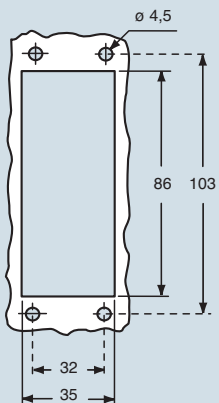

NB:
The enclosures ensure IP65 protection rating when mated and locked with the closing lever, or IP44 protection when not mated and locked with lever.



dimensions shown are not binding and may be changed without notice

SIMPLEX - size 77.27



inserts:	page:
CD 64 poles + ⊕	59
CT, CTS (10A) *) 64 poles + ⊕	65
CDD 108 poles + ⊕	72
CDS 42 poles + ⊕	81
CSH 24 poles + ⊕	94
CNE, CSE 24 poles + ⊕	107
CCE 24 poles + ⊕	113
CSS 24 poles + ⊕	125
CT, CTSE (16A) *) .. 24 poles + ⊕	133
CQE 46 poles + ⊕	141
CQEE 64 poles + ⊕	147
CMCE 10+2 (aux) poles + ⊕	152
CMSH 10+2 (aux) poles + ⊕	153
CX 4/8 and 6/6 poles + ⊕	173 and 175
MIXO 6 modules	179-215

*) can be used only in bulkhead mounting housings

bulkhead mounting housings with single lever

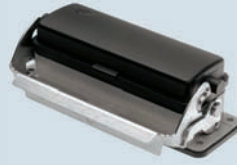

lever in stainless steel

NEW

insert centre distance: **104 x 27 mm**

description	part No.
with lever and cover in plastic, size "104.27"	CVI 24 LSP

panel cut-out for bulkhead mounting housings in mm	dimensions in mm
--	------------------

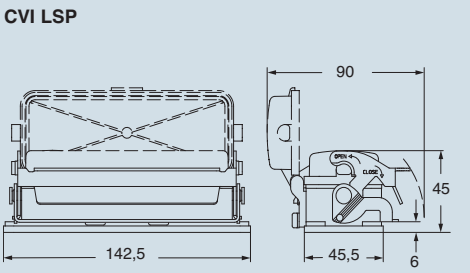
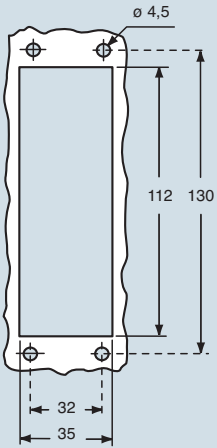

NB:
The enclosures ensure IP65 protection rating when mated and locked with the closing lever, or IP44 protection when not mated and locked with lever.

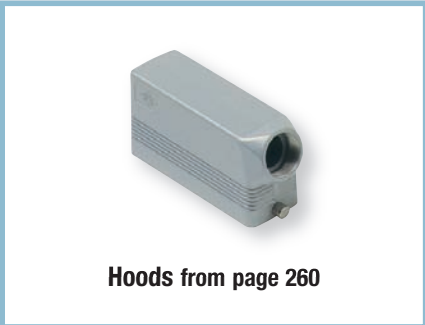

dimensions shown are not binding and may be changed without notice

SIMPLEX - size 104.27