

Hohe Qualität, robuste Ausführung / high quality, robust design  
 Patentierte abgerundete Ecken / patented rounded corners

## GOGATRAY 60 mm

Material	Breite mm	Draht	Gewicht kg/m	ArtNr	VPE m	€ /m.
material	width	wire	weight		PU	/m.
<b>E.G.</b>	60	4,0	0,67	06-60212060	24	<b>4,01</b>
BYCRO		4,0	0,67	06-60222060		4,01
<b>H.D.G.</b>		4,0	0,71	06-60232060		<b>5,81</b>
<b>S.S. 304</b>		4,0	0,67	06-60252060		<b>14,78</b>
S.S. 316	4,0	0,67	06-60262060	18,23		
<b>E.G.</b>	100	4,0	0,95	06-60212100	24	<b>4,97</b>
BYCRO		4,0	0,95	06-60222100		4,97
<b>H.D.G.</b>		4,0	1,01	06-60232100		<b>7,04</b>
<b>S.S. 304</b>		4,0	0,94	06-60252100		<b>19,95</b>
S.S. 316	4,0	0,94	06-60262100	24,60		
<b>E.G.</b>	150	4,5	1,01	06-60212150	24	<b>5,92</b>
BYCRO		4,5	1,01	06-60222150		5,92
<b>H.D.G.</b>		4,5	1,07	06-60232150		<b>7,80</b>
<b>S.S. 304</b>		4,5	1,00	06-60252150		<b>25,27</b>
S.S. 316	4,5	1,00	06-60262150	31,67		
<b>E.G.</b>	200	4,5	1,31	06-60212200	18	<b>7,36</b>
BYCRO		4,5	1,31	06-60222200		7,36
<b>H.D.G.</b>		4,5	1,39	06-60232200		<b>9,92</b>
<b>S.S. 304</b>		4,5	1,30	06-60252200		<b>32,15</b>
S.S. 316	4,5	1,30	06-60262200	40,53		
<b>E.G.</b>	300	5,0	2,07	06-60212300	12	<b>10,63</b>
BYCRO		5,0	2,07	06-60222300		10,63
<b>H.D.G.</b>		5,0	2,19	06-60232300		<b>15,41</b>
<b>S.S. 304</b>		5,0	1,66	06-60252300		<b>40,80</b>
S.S. 316	5,0	1,66	06-60262300	51,70		
<b>E.G.</b>	400	5,0	2,52	06-60212400	6	<b>13,39</b>
BYCRO		5,0	2,52	06-60222400		13,39
<b>H.D.G.</b>		5,0	2,66	06-60232400		<b>18,59</b>
<b>S.S. 304</b>		5,0	2,02	06-60252400		<b>49,97</b>
S.S. 316	5,0	2,02	06-60262400	64,00		
<b>E.G.</b>	500	5,0	2,97	06-60212500	6	<b>17,13</b>
BYCRO		5,0	2,97	06-60222500		17,13
<b>H.D.G.</b>		5,0	3,13	06-60232500		<b>22,69</b>
<b>S.S. 304</b>		5,0	2,38	06-60252500		<b>59,50</b>
S.S. 316	5,0	2,38	06-60262500	77,00		
<b>E.G.</b>	600	5,0	3,42	06-60212600	6	<b>19,86</b>
BYCRO		5,0	3,42	06-60222600		19,86
<b>H.D.G.</b>		5,0	3,61	06-60232600		<b>26,08</b>
<b>S.S. 304</b>		5,0	2,74	06-60252600		<b>68,30</b>
S.S. 316	5,0	2,74	06-60262600	96,40		

Fett gedruckt = Lagertyp / bolded = storage type

## GOGATRAY Gitterwinkel / grating angle

Für direkte Montage an I-Trägern / for direct mounting on I-carrier

Material	Abmessung mm	Gewicht kg/m	ArtNr	VPE Stk.	€ /Stk.
material	dimension	weight		PU	/pc.
BYCRO	109	0,66	06-60220000	18	5,67
H.D.G.	109	0,7	06-60230000	18	6,04
SS 304	109	0,8	06-60250000	18	17,22
SS 316	109	0,8	06-60260000	18	19,92

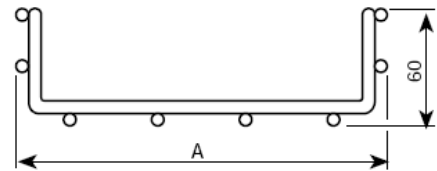
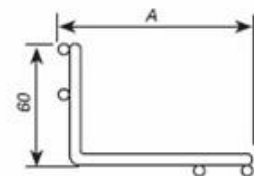
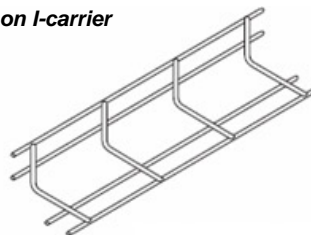

Länge 3000 mm

## E.G., BYCRO and H.D.G.

Width: 60 - 100 - 150 200 300 - 400 500 600

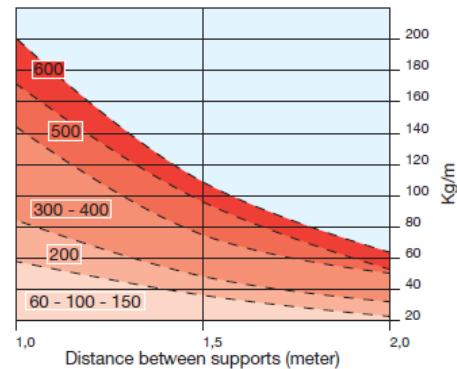

## STAINLESS STEEL

Width: 60 - 100 - 150 200 - 300 - 400 500 600

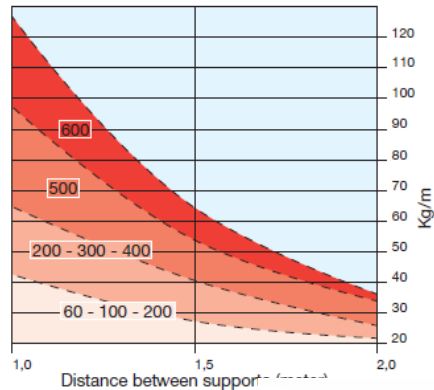

Preise gültig ab 01.01.2018 exkl. MwSt., freibleibend, Auftragsrabatt auf Anfrage / prices are valid from 01.01.2018 excl. VAT, subject to change, discounts upon request  
 sonst. Konditionen siehe [www.gogatec.com/AGB.pdf](http://www.gogatec.com/AGB.pdf), techn. Änderungen vorbehalten / terms & conditions can be found on our website: [www.gogatec.com/AGB.pdf](http://www.gogatec.com/AGB.pdf); error, technical modifications and variations are reserved

Hohe Qualität, robuste Ausführung / high quality, robust design  
 Patentierte abgerundete Ecken / patented rounded corners

**GOGATRAY 35 mm**

Material	Breite	Draht	Gewicht	ArtNr	VPE	€
material	width	wire	kg/m		m	/m.
<b>E.G.</b>	60	4,0	0,65	06-60211060		<b>4,16</b>
BYCRO		4,0	0,65	06-60221060		5,08
<b>H.D.G.</b>		4,0	0,70	06-60231060	24	5,80
<b>S.S. 304</b>		4,0	0,65	06-60251060		<b>12,94</b>
S.S. 316		4,0	0,65	06-60261060		17,47
<b>E.G.</b>	100	4,0	0,65	06-60211100		<b>3,97</b>
BYCRO		4,0	0,65	06-60221100		4,04
<b>H.D.G.</b>		4,0	0,70	06-60231100	24	<b>5,31</b>
<b>S.S. 304</b>		4,0	0,65	06-60251100		<b>14,89</b>
S.S. 316		4,0	0,65	06-60261100		18,83
<b>EG.</b>	150	4,5	0,723	06-60211150		<b>4,55</b>
BYCRO		4,5	0,723	06-60221150	24	4,64
<b>H.D.G.</b>		4,5	0,723	06-60231150		<b>6,15</b>
<b>E.G.</b>	200	4,5	1,01	06-60211200		<b>5,95</b>
BYCRO		4,5	1,01	06-60221200		6,06
<b>H.D.G.</b>		4,5	1,08	06-60231200	18	<b>8,53</b>
<b>S.S. 304</b>		4,5	1,00	06-60251200		<b>26,32</b>
S.S. 316		4,5	1,01	06-60261200		32,89
<b>E.G.</b>	300	4,5	1,38	06-60211300		<b>8,37</b>
BYCRO		4,5	1,38	06-60221300		8,52
<b>H.D.G.</b>		4,5	1,46	06-60231300	18	<b>11,88</b>
<b>S.S. 304</b>		4,5	1,36	06-60251300		<b>36,02</b>
S.S. 316		4,5	1,38	06-60261300		45,57
<b>E.G.</b>	400	4,5	1,77	06-60211400		<b>11,49</b>
BYCRO		4,5	1,77	06-60221400		11,82
<b>H.D.G.</b>		4,5	2,02	06-60231400	12	<b>16,04</b>
<b>S.S. 304</b>		4,5	1,73	06-60251400		<b>50,10</b>
S.S. 316		4,5	1,74	06-60261400		60,10

Fett gedruckt = Lagertyp / bolded = storage type

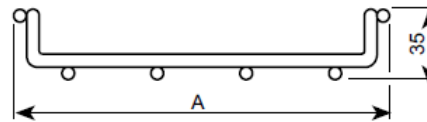

Länge 3000 mm

**E.G., BYCRO and H.D.G.**

Width: 100 - 200 - 300 400

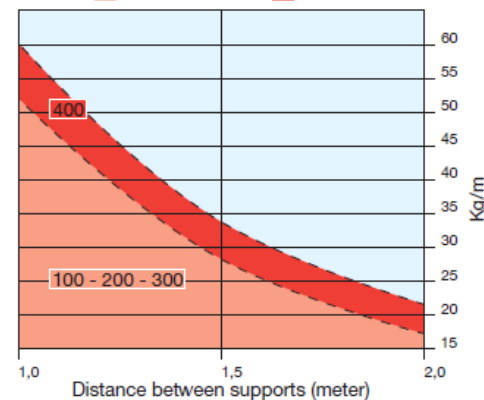

**Materialien und Korrosionsbeständigkeit (nach BS-EN 61537):**

Materials and corrosion resistance (according to BS EN 61537):

Material	Materialbezeichnung	Beständig/h
material	material	resistant/h
P.G.	Sendzimirgalvanisiert nach / sendzimir galvanized to UNE EN 10346	190
E.G.	Elektro galvanisiert nach / electro galvanized to BS-EN ISO 2081	190
BYCRO	Verzinkt und bichromatiert nach / galvanized and bichromated to BS-EN ISO 2081	440
H.D.G.	Feuerverzinkt nach / hot-dip galvanized to BS-EN ISO 10346	660
S.S. 304	Edelstahl / stainless steel AISI 304 (V2A)	>850
S.S. 316	Edelstahl / stainless steel AISI 316 (V4A)	>850

**STAINLESS STEEL**

Width: 100 - 200 - 300 400

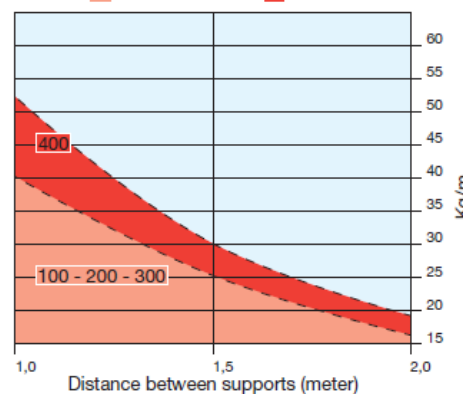

Preise gültig ab 01.01.2018 exkl. MwSt., freibleibend, Auftragsrabatt auf Anfrage / prices are valid from 01.01.2018 excl. VAT, subject to change, discounts upon request  
 sonst. Konditionen siehe [www.gogatec.com/AGB.pdf](http://www.gogatec.com/AGB.pdf), techn. Änderungen vorbehalten / terms & conditions can be found on our website: [www.gogatec.com/AGB.pdf](http://www.gogatec.com/AGB.pdf), error, technical modifications and variations are reserved

Hohe Qualität, robuste Ausführung / high quality, robust design  
 Patentierte abgerundete Ecken / patented round corners

**GOGATRAY 100 mm**

Material	Breite mm	Draht	Gewicht kg/m	ArtNr	VPE m	€ /m.
<i>material</i>	<i>width</i>	<i>wire</i>	<i>weight</i>		<i>PU</i>	<i>/m.</i>
<b>EG</b>		5,0	1,316	06-60213100		<b>7,44</b>
BYCRO		5,0	1,316	06-60223100		7,51
<b>H.D.G.</b>	100	5,0	1,316	06-60233100	12	<b>10,45</b>
<b>S.S. 304</b>		5,0	1,316	06-60253100		<b>31,90</b>
S.S. 316		5,0	1,316	06-60263100		35,55
<b>EG</b>		5,0	1,383	06-60213150		<b>8,26</b>
BYCRO		5,0	1,383	06-60223150		8,34
<b>H.D.G.</b>	150	5,0	1,383	06-60233150	6	<b>11,35</b>
<b>S.S. 304</b>		5,0	1,383	06-60253150		<b>30,89</b>
S.S. 316		5,0	1,383	06-60263150		45,15
<b>E.G.</b>		5,0	2,06	06-60213200		<b>11,32</b>
BYCRO		5,0	2,06	06-60223200		11,53
<b>H.D.G.</b>	200	5,0	2,17	06-60233200	6	<b>15,96</b>
<b>S.S. 304</b>		5,0	1,65	06-60253200		<b>41,03</b>
S.S. 316		5,0	1,65	06-60263200		54,40
<b>E.G.</b>		5,0	2,51	06-60213300		<b>14,02</b>
BYCRO		5,0	2,51	06-60223300		14,02
<b>H.D.G.</b>	300	5,0	2,65	06-60233300	6	<b>19,26</b>
<b>S.S. 304</b>		5,0	2,01	06-60253300		<b>49,54</b>
S.S. 316		5,0	2,03	06-60263300		65,80
<b>E.G.</b>		5,0	2,96	06-60213400		<b>17,46</b>
BYCRO		5,0	2,96	06-60223400		17,46
<b>H.D.G.</b>	400	5,0	3,12	06-60233400	6	<b>25,05</b>
<b>S.S. 304</b>		5,0	2,37	06-60253400		<b>60,10</b>
S.S. 316		5,0	2,37	06-60263400		77,60
<b>E.G.</b>		5,0	3,41	06-60213500		<b>21,40</b>
BYCRO		5,0	3,41	06-60223500		21,40
<b>H.D.G.</b>	500	5,0	3,60	06-60233500	6	<b>30,06</b>
<b>S.S. 304</b>		5,0	2,73	06-60253500		<b>72,50</b>
S.S. 316		5,0	2,76	06-60263500		92,00
<b>E.G.</b>		5,0	3,86	06-60213600		<b>23,95</b>
BYCRO		5,0	3,86	06-60223600		23,95
<b>H.D.G.</b>	600	5,0	4,07	06-60233600	6	<b>33,41</b>
<b>S.S. 304</b>		5,0	3,09	06-60253600		<b>77,20</b>
S.S. 316		5,0	3,12	06-60263600		96,40

Fett gedruckt = Lagertyp / *bolded* = storage type

**Materialien und Korrosionsbeständigkeit (nach BS-EN 61537):**  
 Materials and corrosion resistance (according to BS EN 61537):

Material	Materialbezeichnung	Beständig/h
<i>material</i>	<i>material</i>	<i>resistant/h</i>
P.G.	Sendzimirgalvanisiert nach / <i>sendzimir galvanized</i> to UNE EN 10346	190
E.G.	Elektro galvanisiert nach / <i>electro galvanized</i> to BS-EN ISO 2081	190
BYCRO	Verzinkt und bichromatiert nach / <i>galvanized and bichromated</i> to BS-EN ISO 2081	440
H.D.G.	Feuerverzinkt nach / <i>hot-dip galvanized</i> to BS-EN ISO 10346	660
S.S. 304	Edelstahl / <i>stainless steel</i> AISI 304 (V2A)	>850
S.S. 316	Edelstahl / <i>stainless steel</i> AISI 316 (V4A)	>850

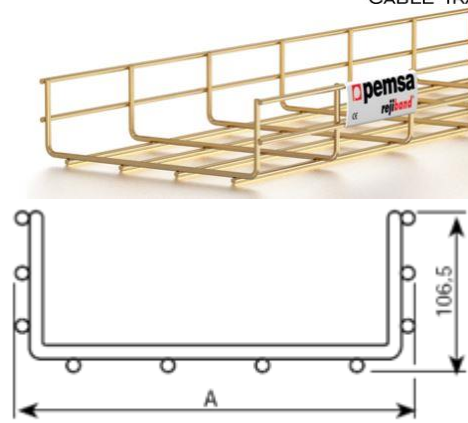

Länge 3000 mm

E.G., BYCRO and H.D.G.

Width: 60 - 100 - 150 200 300 - 400 500 600

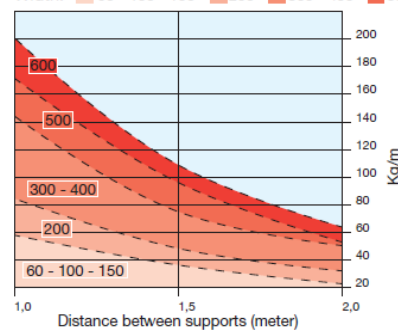

**STAINLESS STEEL**

Width: 60 - 100 - 150 200 - 300 - 400 500 600

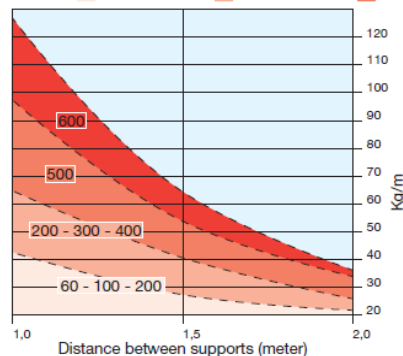

Preise gültig ab 01.01.2018 exkl. MwSt., freibleibend, Auftragsrabatt auf Anfrage / prices are valid from 01.01.2018 excl. VAT, subject to change, discounts upon request  
 sonst. Konditionen siehe [www.gogatec.com/AGB.pdf](http://www.gogatec.com/AGB.pdf), techn. Änderungen vorbehalten /  
 terms & conditions can be found on our website: [www.gogatec.com/AGB.pdf](http://www.gogatec.com/AGB.pdf); error, technical modifications and variations are reserved