

GOGAPIN KKS3-RK Quetschkabelschuh-Ring isoliert, easy entry / insulated solderless cable lug ring, easy entry

Material / material: E-Cu, gal. Sn, gelötet
Material Isolation / insulation: Nylon transparent / nylon transparent
Temperaturbereich / temperature range: -60°C - +105°C
Zulassung / approval: UL listed
Normen / standards: DIN 46237, DIN 46234
Rohr/Hals gelötet / tube brazed

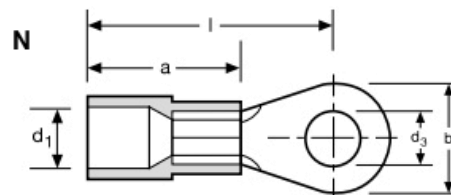

Passende Werkzeuge siehe GOGATOOL Katalog / for appropriate tools please see GOGATOOL catalog

FC	Typ type	Bereich mm² range	Loch für hole size	Abmessungen mm dimensions mm					ArtNr	VPE Stk. /100 Stk. PU /100 pcs.	€	
				d3	b	d1	l	a				s
RT	KKS3-RK-1,5-M2,5	0,5 - 1,5	M2,5	2,7	6,0	4,0	16,0	10,0	0,8	1212100015025	100	8,37
	KKS3-RK-1,5-M3		M3	3,2	6,0	4,0	16,0	10,0	0,8	121210001503	100	8,44
	KKS3-RK-1,5-M3,5		M3,5	3,7	6,0	4,0	16,0	10,0	0,8	1212100015035	100	8,44
	KKS3-RK-1,5-M4		M4	4,3	8,0	4,0	17,0	10,0	0,8	121210001504	100	8,90
	KKS3-RK-1,5-M5		M5	5,3	10,0	4,0	18,0	10,0	0,8	121210001505	100	9,62
	KKS3-RK-1,5-M6		M6	6,5	11,0	4,0	21,0	10,0	0,8	121210001506	100	8,54
	KKS3-RK-1,5-M8		M8	8,4	14,0	4,0	22,0	10,0	0,8	121210001508	100	11,92
	KKS3-RK-1,5-M10		M10	10,5	18,0	4,0	22,0	10,0	0,8	121210001510	100	16,18
BL	KKS3-RK-2,5-M3	1,5 - 2,5	M3	3,2	6,0	4,5	17,0	11,0	0,8	121210002503	100	9,16
	KKS3-RK-2,5-M3,5		M3,5	3,7	6,0	4,5	17,0	11,0	0,8	1212100025035	100	7,75
	KKS3-RK-2,5-M4		M4	4,3	8,0	4,5	18,0	11,0	0,8	121210002504	100	9,75
	KKS3-RK-2,5-M5		M5	5,3	10,0	4,5	20,0	11,0	0,8	121210002505	100	10,41
	KKS3-RK-2,5-M6		M6	6,5	11,0	4,5	22,0	11,0	0,8	121210002506	100	8,01
	KKS3-RK-2,5-M8		M8	8,4	14,0	4,5	23,0	11,0	0,8	121210002508	100	12,87
	KKS3-RK-2,5-M10		M10	10,5	18,0	4,5	25,0	11,0	0,8	121210002510	100	16,90
	KKS3-RK-2,5-M12		M12	13,0	18,0	4,5	25,0	11,0	0,8	121210002512	100	24,55
GE	KKS3-RK-6,0-M4	4,0 - 6,0	M4	4,3	8,0	6,6	20,0	14,0	1,0	121210006004	100	14,57
	KKS3-RK-6,0-M5		M5	5,3	10,0	6,6	21,0	14,0	1,0	121210006005	100	14,57
	KKS3-RK-6,0-M6		M6	6,5	11,0	6,6	22,0	14,0	1,0	121210006006	100	19,20
	KKS3-RK-6,0-M8		M8	8,4	14,0	6,6	25,0	14,0	1,0	121210006008	100	19,20
	KKS3-RK-6,0-M10		M10	10,5	18,0	6,6	27,0	14,0	1,0	121210006010	100	20,71
	KKS3-RK-6,0-M12		M12	13,0	19,0	6,6	32,0	14,0	1,0	121210006012	100	22,81
	KKS3-RK-6,0-M14		M14	15,0	19,0	6,6	32,0	14,0	1,0	121210006014	100	64,70



GOGAPIN KKS3-SV Stoßverbinder isoliert, easy entry / insulated butt, easy entry

Material / material: E-Cu, gal. Sn
Material Isolation / insulation: Nylon transparent / nylon transparent
Temperaturbereich / temperature range: -60°C - +105°C
Zulassung / approval: UL listed

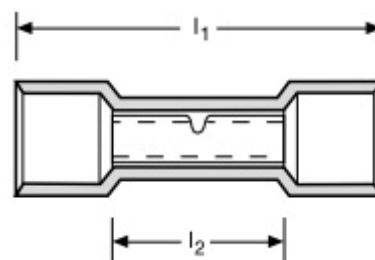

Passende Werkzeuge siehe GOGATOOL Katalog / for appropriate tools please see GOGATOOL catalog

FC	Typ type	Bereich mm² range	Abmessungen mm dimensions mm			ArtNr	VPE Stk. /100 Stk. PU /100 pcs.	€
			l1	l2	s			
RT	KKS3-SV-1,5	0,5 - 1,5	25,0	15,0	0,8	1212800015	100	6,86
BL	KKS3-SV-2,5	1,5 - 2,5	25,0	15,0	0,8	1212800025	100	8,38
GE	KKS3-SV-6,0	4,0 - 6,0	27,0	15,0	1,0	1212800060	100	13,24



Preise gültig ab 01.01.2019 exkl. MwSt., freibleibend, Auftragsrabatt auf Anfrage /
 prices are valid from 01.01.2019 excl. VAT, subject to change, discounts upon request
 sonst. Konditionen siehe www.gogatec.com/AGB.pdf, techn. Änderungen vorbehalten /
 terms & conditions can be found on our website: www.gogatec.com/AGB.pdf; error, technical modifications and variations are reserved

GOGAPIN KKS3-GK Quetschkabelschuh-Gabel isoliert, easy entry / insulated solderless cable lug fork, easy entry

Material / material: E-Cu, gal. Sn, gelötet
Material Isolation / insulation: Nylon transparent / nylon transparent
Temperaturbereich / temperature range: -60°C - +105°C
Zulassung / approval: UL listed
Normen / standards: DIN 46237 und ähnlich / and similar

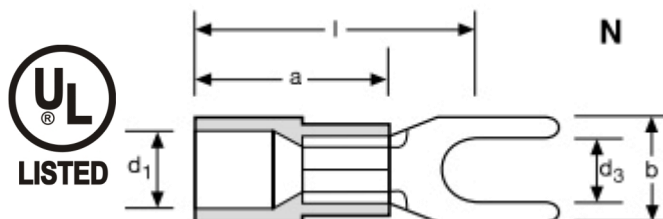

Passende Werkzeuge siehe GOGATOOL Katalog / for appropriate tools please see GOGATOOL catalog

FC	Typ type	Bereich mm ² range	Loch für hole size	Abmessungen mm dimensions mm						ArtNr	VPE Stk. /100 Stk. PU /100 pcs.	€
				d3	b	d1	l	a	s			
RT	KKS3-GK-1,5-M3	0,5 - 1,5	M3	3,2	5,7	4,1	17,7	10,0	0,8	121220001503	100	8,44
	KKS3-GK-1,5-M3,5		M3,5	3,7	6,0	4,1	17,7	10,0	0,8	1212200015035	100	8,44
	KKS3-GK-1,5-M4		M4	4,3	7,2	4,1	17,0	10,0	0,8	121220001504	100	8,44
	KKS3-GK-1,5-M5		M5	5,3	8,0	4,1	17,0	10,0	0,8	121220001505	100	9,09
	KKS3-GK-1,5-M6		M6	6,4	10,7	4,1	18,5	10,0	0,8	121220001506	100	11,85
	KKS3-GK-1,5-M8	M8	8,4	13,5	4,1	21,5	10,0	0,8	121220001508	100	25,63	
BL	KKS3-GK-2,5-M3	1,5 - 2,5	M3	3,2	5,7	4,5	17,5	11,0	0,8	121220002503	100	9,32
	KKS3-GK-2,5-M3,5		M3,5	3,7	6,2	4,5	17,5	11,0	0,8	1212200025035	100	9,32
	KKS3-GK-2,5-M4		M4	4,3	7,2	4,5	17,5	11,0	0,8	121220002504	100	9,62
	KKS3-GK-2,5-M5		M5	5,3	8,0	4,5	17,5	11,0	0,8	121220002505	100	9,75
	KKS3-GK-2,5-M6		M6	6,4	10,7	4,5	18,6	11,0	0,8	121220002506	100	8,63
	KKS3-GK-2,5-M10	M10	10,5	15,0	4,5	23,0	10,0	0,8	121220002510	100	23,04	
GE	KKS3-GK-6,0-M3,5	4,0 - 6,0	M3,5	3,7	8,1	6,6	21,1	14,0	1,0	1212200060035	100	15,10
	KKS3-GK-6,0-M4		M4	4,3	8,2	6,6	21,5	14,0	1,0	121220006004	100	15,10
	KKS3-GK-6,0-M5		M5	5,3	9,0	6,6	22,0	14,0	1,0	121220006005	100	16,25
	KKS3-GK-6,0-M6		M6	6,4	12,0	6,6	23,5	14,0	1,0	121220006006	100	19,20
	KKS3-GK-6,0-M8		M8	8,4	13,5	6,6	25,0	14,0	1,0	121220006008	100	23,04
	KKS3-GK-6,0-M10	M10	10,5	18,0	6,4	27,0	12,0	1,0	121220006010	100	33,70	



**GOGAPIN KKS3-SK Stiftkabelschuh isoliert, easy entry /
insulated pin cable lug, easy entry**

Material / material: E-Cu, gal. Sn, gelötet
Material Isolation / insulation: Nylon transparent / nylon transparent
Temperaturbereich / temperature range: -60°C - +105°C
Zulassung / approval: UL listed
Normen / standards: DIN 46231 und ähnlich / and similar

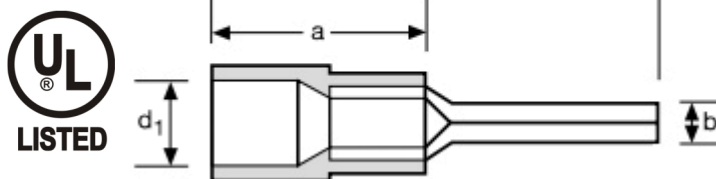

Passende Werkzeuge siehe GOGATOOL Katalog / for appropriate tools please see GOGATOOL catalog

FC	Typ type	Bereich mm ² range	Stift mm pin	Abmessungen mm dimensions mm					ArtNr	VPE Stk. /100 Stk. PU /100 pcs.	€
				b	d1	l	a	s			
RT	KKS3-SK-1,5-1909	0,5 - 1,5	9,0	1,9	4,1	19,0	10,0	0,8	12123000151909	100	10,47
	KKS3-SK-1,5-1912		12,0	1,9	4,1	22,0	10,0	0,8	12123000151912	100	10,47
BL	KKS3-SK-2,5-1909	1,5 - 2,5	9,0	1,9	4,5	20,0	11,0	0,8	12123000251909	100	11,06
	KKS3-SK-2,5-1911		11,0	1,9	4,5	23,5	11,0	0,8	12123000251911	100	11,06
GE	KKS3-SK-6,0-2714	4,0 - 6,0	14,0	2,7	6,6	27,0	13,0	1,0	12123000602714	100	15,23



Preise gültig ab 01.01.2019 exkl. MwSt., freibleibend, Auftragsrabatt auf Anfrage /
prices are valid from 01.01.2019 excl. VAT, subject to change, discounts upon request
sonst. Konditionen siehe www.gogatec.com/AGB.pdf, techn. Änderungen vorbehalten /
terms & conditions can be found on our website: www.gogatec.com/AGB.pdf; error, technical modifications and variations are reserved

GOGAPIN KKS3-FH Flachsteckhülse isoliert, easy entry / insulated female disconnect, easy entry

Material: Messing, gal. verzinkt / brass tin-plated
Material Isolation / insulation: Nylon transparent / nylon transparent
Temperaturbereich / temperature range: -60°C - +105°C
Zulassung / approval: UL listed
Normen / standards: DIN 46245 und ähnlich / and similar

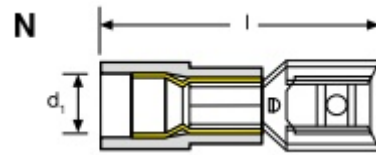

Passende Werkzeuge siehe GOGATOOL Katalog / for appropriate tools please see GOGATOOL catalog

FC	Typ type	Bereich mm ² range	Steckgröße mm tab size	Abmessung mm dimensions mm			ArtNr	VPE €	
				l	d1	s		Stk. /100 Stk. PU /100 pcs.	
RT	KKS3-FH-1,5-2805	0,5 - 1,5	2,8 - 0,5	19,0	4,1	0,25	12125000152805	100	9,09
	KKS3-FH-1,5-2808		2,8 - 0,8	19,0	4,1	0,25	12125000152808	100	9,09
	KKS3-FH-1,5-4805		4,8 - 0,5	19,5	4,1	0,40	12125000154805	100	10,47
	KKS3-FH-1,5-4808		4,8 - 0,8	19,5	4,1	0,40	12125000154808	100	10,47
	KKS3-FH-1,5-6308		6,3 - 0,8	21,5	4,1	0,40	12125000156308	100	9,98
	KKS3-FH-1,5-8008		8,0 - 0,8	24,5	4,1	0,40	12125000158008	100	17,69
BL	KKS3-FH-2,5-2805	1,5 - 2,5	2,8 - 0,5	19,5	5,0	0,25	12125000252805	100	9,98
	KKS3-FH-2,5-2808		2,8 - 0,8	19,5	5,0	0,25	12125000252808	100	8,63
	KKS3-FH-2,5-4805		4,8 - 0,5	20,0	5,0	0,40	12125000254805	100	11,49
	KKS3-FH-2,5-4808		4,8 - 0,8	20,0	5,0	0,40	12125000254808	100	11,49
	KKS3-FH-2,5-6308		6,3 - 0,8	21,5	5,0	0,40	12125000256308	100	10,34
	KKS3-FH-2,5-8008		8,0 - 0,8	24,5	5,0	0,40	12125000258008	100	17,63
GE	KKS3-FH-6,0-2805	4,0 - 6,0	2,8 - 0,5	22,5	6,6	0,40	12125000602805	100	15,10
	KKS3-FH-6,0-2808		2,8 - 0,8	22,5	6,6	0,40	12125000602808	100	15,10
	KKS3-FH-6,0-4805		4,8 - 0,5	23,0	6,6	0,40	12125000604805	100	15,10
	KKS3-FH-6,0-4808		4,8 - 0,8	23,0	6,6	0,40	12125000604808	100	15,10
	KKS3-FH-6,0-6308		6,3 - 0,8	24,0	6,6	0,40	12125000606308	100	17,20
	KKS3-FH-6,0-9512		9,5 - 1,2	28,6	6,6	0,40	12125000609512	100	20,02



GOGAPIN KKS3-FHVI Flachsteckhülse vollisoliert, easy entry / fully insulated female disconnect, easy entry

Material: Messing, gal. verzinkt / brass tin-plated
Material Isolation / insulation: Nylon transparent / nylon transparent
Temperaturbereich / temperature range: -60°C - +105°C
Zulassung / approval: UL listed

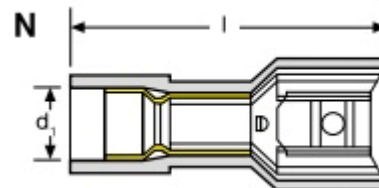

Passende Werkzeuge siehe GOGATOOL Katalog / for appropriate tools please see GOGATOOL catalog

FC	Typ type	Bereich mm ² range	Steckgröße mm tab size	Abmessung mm dimensions mm			ArtNr	VPE €	
				l	d1	s		Stk. /100 Stk. PU /100 pcs.	
RT	KKS3-FHVI-1,5-2805	0,5 - 1,5	2,8 - 0,5	20,5	4,1	0,25	12125100152805	100	10,31
	KKS3-FHVI-1,5-2808		2,8 - 0,8	20,5	4,1	0,25	12125100152808	100	10,18
	KKS3-FHVI-1,5-4805		4,8 - 0,5	20,5	4,1	0,40	12125100154805	100	10,18
	KKS3-FHVI-1,5-4808		4,8 - 0,8	20,5	4,1	0,40	12125100154808	100	21,07
	KKS3-FHVI-1,5-6308		6,3 - 0,8	22,0	4,1	0,40	12125100156308	100	10,93
	KKS3-FHVI-2,5-4805		4,8 - 0,5	21,5	4,9	0,40	12125100254805	100	18,48
BL	KKS3-FHVI-2,5-4808	1,5 - 2,5	4,8 - 0,8	21,5	4,9	0,40	12125100254808	100	10,47
	KKS3-FHVI-2,5-6308		6,3 - 0,8	22,5	4,9	0,40	12125100256308	100	10,90
GE	KKS3-FHVI-6,0-6308	4,0 - 6,0	6,3 - 0,8	25,0	6,7	0,40	12125100606308	100	16,02



Preise gültig ab 01.01.2019 exkl. MwSt., freibleibend, Auftragsrabatt auf Anfrage /
 prices are valid from 01.01.2019 excl. VAT, subject to change, discounts upon request
 sonst. Konditionen siehe www.gogatec.com/AGB.pdf, techn. Änderungen vorbehalten /
 terms & conditions can be found on our website: www.gogatec.com/AGB.pdf; error, technical modifications and variations are reserved

GOGAPIN KKS3-FS Flachstecker isoliert, easy entry / insulated male disconnects, easy entry

Material: Messing, gal. verzinkt / brass tin-plated
Material Isolation / insulation: Nylon transparent / nylon transparent
Temperaturbereich / temperature range: -60°C - +105°C
Zulassung / approval: UL listed
Rohr/Hals gelötet / tube brazed

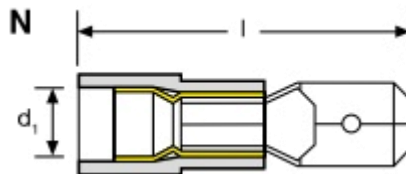

Passende Werkzeuge siehe GOGATOOL Katalog / for appropriate tools please see GOGATOOL catalog

FC	Typ type	Bereich mm ² range	Steckgröße mm tab size	Abmessungen mm dimensions mm			ArtNr	VPE Stk. /100 Stk. PU /100 pcs.	€
				l	d1	s			
RT	KKS3-FS-1,5-2805	0,5 - 1,5	2,8 - 0,5	22,0	4,1	0,25	12124000152805	100	19,20
	KKS3-FS-1,5-2808		2,8 - 0,8	22,0	4,1	0,40	12124000152808	100	19,20
	KKS3-FS-1,5-4805		4,8 - 0,5	22,0	4,1	0,25	12124000154805	100	19,20
	KKS3-FS-1,5-4808		4,8 - 0,8	22,0	4,1	0,40	12124000154808	100	19,20
	KKS3-FS-1,5-6308		6,3 - 0,8	22,0	4,1	0,40	12124000156308	100	9,98
BL	KKS3-FS-2,5-4805	1,5 - 2,5	4,8 - 0,5	22,5	5,0	0,25	12124000254805	100	19,20
	KKS3-FS-2,5-4808		4,8 - 0,8	22,5	5,0	0,40	12124000254808	100	19,20
	KKS3-FS-2,5-6308		6,3 - 0,8	22,5	5,0	0,40	12124000256308	100	10,96
GE	KKS3-FS-6,0-4805	4,0 - 6,0	4,8 - 0,5	24,5	6,6	0,25	12124000604805	100	19,20
	KKS3-FS-6,0-4808		4,8 - 0,8	24,5	6,6	0,40	12124000604808	100	19,20
	KKS3-FS-6,0-6308		6,3 - 0,8	24,5	6,6	0,40	12124000606308	100	16,25



GOGAPIN KKS3-FH90 Flachsteckhülse seilt. Leiteranschluss isoliert, easy entry / insulated female disconnects flag-type, easy entry

Material: Messing, gal. verzinkt / brass tin-plated
Material Isolation / insulation: Nylon transparent / nylon transparent
Temperaturbereich / temperature range: -60°C - +105°C
Zulassung / approval: UL listed

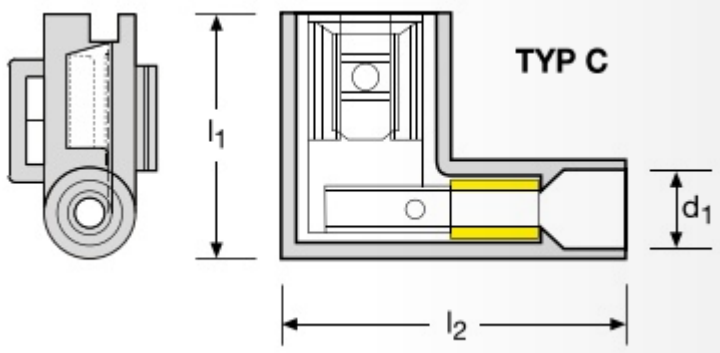

Passende Werkzeuge siehe GOGATOOL Katalog / for appropriate tools please see GOGATOOL catalog

FC	Typ type	Bereich mm ² range	Steckgröße mm tab-width	Abmessungen mm dimensions mm			ArtNr	VPE Stk. /100 Stk. PU /100 pcs.	€
				l1	l2	s			
RT	KKS3-FH90-1,5-4808	0,5 - 1,5	4,8 - 0,8	14,5	19,0	3,6	12125800154808	100	21,20
	KKS3-FH90-1,5-6308		6,3 - 0,8	16,5	20,6	3,9	12125800156308	100	26,68
BL	KKS3-FH90-2,5-6308	1,5 - 2,5	6,3 - 0,8	16,6	20,8	4,4	12125800256308	100	32,55
GE	KKS3-FH90-6,0-6308	4,0 - 6,0	6,3 - 0,8	17,5	23,0	6,3	12125800606308	100	34,62



Preise gültig ab 01.01.2019 exkl. MwSt., freibleibend, Auftragsrabatt auf Anfrage /
prices are valid from 01.01.2019 excl. VAT, subject to change, discounts upon request
sonst. Konditionen siehe www.gogatec.com/AGB.pdf, techn. Änderungen vorbehalten /
terms & conditions can be found on our website: www.gogatec.com/AGB.pdf; error, technical modifications and variations are reserved

Kleinkabelschuhe isoliert Nylon transparent / insulated mini cable lugs nylon transparent

GOGAPIN KKS3-FV Flachsteckhülse mit Abzweig isoliert, easy entry / insulated piggy back disconnects disconnects, easy entry

Material: Messing, gal. verzinkt / brass tin-plated
Isolation / insulation: Nylon transparent / nylon transparent
Temperaturbereich / temperature range: -60°C bis +105°C
Zulassung / approval: UL listed
Rohr/Hals gelötet / tube brazed

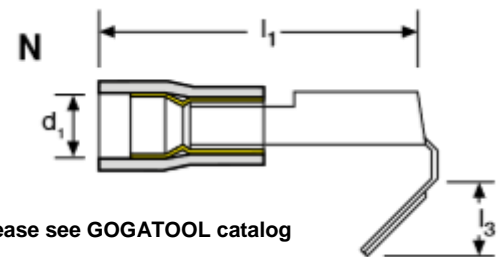

Passende Werkzeuge siehe GOGATOOL Katalog / for appropriate tools please see GOGATOOL catalog

FC	Typ type	Bereich mm ² range	Steckgröße mm tab size	Abmessung mm dimensions mm				ArtNr	VPE Stk. /100 Stk. PU /100 pcs.		€
				l1	d1	l3	s				
RT	KKS3-FV-1,5-6308	0,5 - 1,5	6,3 - 0,8	22,5	4,1	8,2	0,4	12126000156308	100	17,62	
BL	KKS3-FV-2,5-6308	1,5 - 2,5	6,3 - 0,8	23,0	5,0	8,2	0,4	12126000256308	100	12,53	
GE	KKS3-FV-6,0-6308	4,0 - 6,0	6,3 - 0,8	26,0	6,6	8,2	0,4	12126000606308	100	15,32	



Preise gültig ab 01.01.2019 exkl. MwSt., freibleibend, Auftragsrabatt auf Anfrage /
prices are valid from 01.01.2019 excl. VAT, subject to change, discounts upon request
sonst. Konditionen siehe www.gogatec.com/AGB.pdf, techn. Änderungen vorbehalten /
terms & conditions can be found on our website: www.gogatec.com/AGB.pdf; error, technical modifications and variations are reserved