

Aufschnappbar auf DIN-Hutschiene TS35 / snappable on DIN rail TS35
Querverbindung steckbar / pluggable cross connection

Querverbindung steckbar / pluggable cross connection

Isolierkörper / insulating part: Polyamid 6.6

Verbindungssteg / connecting web: Messing / brass

Zugbügelklemme und Schraube / box clamp and screw: Stahl verzinkt, gelb chromatisiert / galvanized steel, yellow chromated

Zulassungen / approvals: Kema EX II GD EEx e II 03ATEX2118U

Kriechstromfestigkeit / comparative tracking: IEC 112: CTI > 600, VDE 0303: KB > 600

GOGATERM EURO RK grau / grey

Nennquerschnitt (mm ²) / nominal cross section	2,5	4	6
Typ EURO RK	2,5/35	4/35	5/35
Klemmenbreite (mm) / clamping width	5	6	7
Flexible Leiter (mm ²) / flexible conductors	0,5-2,5	0,5-4	0,5-6
Feste Leiter (mm ²) / solid conductors	0,5-4	0,5-6	0,5-10
Leiter m. Aderendhülsen (mm ²) / cond. W. CES	0,5-2,5	0,5-4	0,5-6
AWG	24-12	24-10	22-8
Kaliber / caliber	A3	A4	A5
Anzahl anschließb. Leiter / numb. of connectable cond.	2x1,5/4x1	4x1,5	2x4
Leiterraufnahmeraum (mm) / connecting capacity	3,6x2,6	4x3,3	5x4
Leiter abisolieren (mm) / conductor stripping	10	10	12
Schraubengewinde / screw thread	M 2,6	M 3	M 3,5
max. Anzugsdrehmoment (Nm) / max tightening torque	0,5	0,6	1,2
Mittelgewinde / central thread	M 2,5	M 3	M 3
Normen / norms SEV	750V/24A	800V/25A	-
VDE	1000V/24A	1000V/32A	-
Eex e II Kema	630V/24A	750V/25A	-
RINA	800V/24A	800V/32A	-
UL	600V/20A	600V/30A	600V/41A
CSA	600V/25A	600V/25A	-
Abmessungen (mm) / dimensions	5x44x36	6x44x36	7x50x44
Verpackungseinheit / PU	100	100	50
ArtNr	44-43408	44-43409	44-43407
€/Stk. /pc.	0,54	0,56	0,89

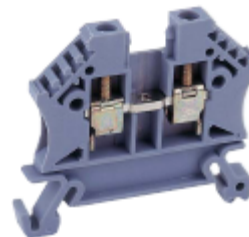

a.A. = auf Anfrage / upon request

Feindrätig mit Aderendhülse - ein Nennquerschnitt kleiner! /
stranded with cord end sleeve - smaller nominal cross-section!

GOGATERM EURO RK bunt / colored

Nennquerschnitt / nominal cross section	2,5	4
blau / blue	44-43408BL	44-43409BL
schwarz / black	44-43408BK	44-43409BK
braun / brown	44-43408BR	44-43409BR
€/Stk. /pc.	0,72	0,74
grün-gelb / green-yellow	44-43408E	44-43409E
€/Stk. /pc.	0,88	0,91

ACHTUNG! / ATTENTION!

Keine Verbindung zur Hutschiene!
 Siehe ERDUNGSKLEMMEN! /
 No connection to the DIN rail!
 See grounding clamps!

Preise gültig ab 01.01.2018 exkl. MwSt., freibleibend, Auftragsrabatt auf Anfrage /

prices are valid from 01.01.2018 excl. VAT, subject to change, discounts upon request

sonst. Konditionen siehe www.gogatec.com/AGB.pdf, techn. Änderungen vorbehalten /

terms & conditions can be found on our website: www.gogatec.com/AGB.pdf; error, technical modifications and variations are reserved

Aufschnappbar auf DIN-Hutschiene TS35 / snappable on DIN rail TS35
Querverbindung schraubbar / screwing cross connection

Isolierkörper / insulating part: Polyamid 6.6

Verbindungssteg / connecting web: Messing / brass

Zugbügelklemme und Schraube / box clamp and screw: Stahl verzinkt, gelb chromatisiert / galvanized steel, yellow chromated

Zulassungen / approvals: Kema EX II GD EEx e II 03ATEX2118U

Kriechstromfestigkeit / comparative tracking: IEC 112: CTI > 600, VDE 0303: KB > 600



GOGATEM EURO RK grau / grey

Nennquerschnitt (mm ²) / nominal cross section	6	10	16-25	35-50	70	95
Typ EURO	6/35	10/35	25/35	50/35	70/35	95/35
Klemmenbreite / clamping width	7	9 mm	12 mm	16 mm	26 mm	-
Flexible Leiter (mm ²) / flexible conductors	0,5-6	1,5-10	1,5-16	2,5-50	16-70	16-95
Feste Leiter (mm ²) / solid conductors	0,5-10	1,5-16	1,5-25	2,5-50	16-70	16-95
Leiter m. Aderendhülsen (mm ²) / cond. W. CES	0,5-6	1,5-10	1,5-16	2,5-35	16-70	-
AWG	22-8	20-6	14-4	14-1/0	4-3/0	3/0
Kaliber / caliber	A5	B6	B7	B9	B11	-
Anz. anschließb. Leiter / numb. of connectable cond.	2x4	2x6	2x10	2x25	2x50	-
Leiterraum (mm) / connecting capacity	5x4	6x5,5	7x7,4	11x10	15,5x16,5	-
Leiter abisolieren (mm) / stripping conductor	12	12	14	17	26	26
Schraubengewinde / screwing thread	M3,5	M 4	M 5	M 6	M 8	-
max. Anzugsdrehmoment (Nm) / max. tight. torque	1,2	2,0	3,0	5,0	10,0	4,5
Mittelgewinde / central thread	M3	M 3	M 4	M 4	x	x
Normen / norms						
SEV	800V/55A	800V/80A	800V/101A	800V/150A	800V/192A	i.V.
VDE	1000V/41A	1000V/57A	1000V/101A	1000V/150A	800V/192A	i.V.
Eex e II Kema	750V	750V/80A	750V/105A	750V/140A	750V/150A	i.V.
RINA	800V/41A	800V/57A	800V/101A	800V/150A	800V/192A	i.V.
UL	600V/50A	600V/65A	600V/85A	600V/130A	600V/185A	i.V.
CSA	600V/50A	600V/80A	600V/105A	600V/130A	600V/185A	i.V.
Abmessungen (mm) / dimensions	7x50x44	9x50x44	12x56x49	16x62x61	26x74x75	26x74x75
Verpackungseinheit / PU	50	50	25	25	10	10
ArtNr	44-43401	44-43402	44-43403	44-43404	44-43405	44-43426
€/Stk. /pc.	1,1	1,42	1,94	3,30	10,66	12,61

GOGATEM EURO RK bunt / colored

Nennquerschnitt mm ² / nominal cross section mm ²	6	10	16-25	35-50	70	95
blau / blue	44-43401BL	44-43402BL	44-43403BL	44-43404BL	44-43405BL	44-43426BL
schwarz / black	-	-	-	-	-	-
braun / brown	-	-	-	-	-	-
rot / red	-	-	-	44-43404RD	-	-
gelb / yellow	-	-	-	-	44-43405N	-
€/Stk. /pc.	1,17	1,47	2,07	3,39	11,51	13,80
grün-gelb / green-yellow	44-43401E	44-43402E	44-43403E	44-43404E	44-43405E	-
€/Stk. /pc.	1,30	1,70	2,28	3,73	11,87	-

Weitere Farben auf Anfrage / other colors on request

ACHTUNG! / ATTENTION!
 Keine Verbindung zur Hutschiene!
 Siehe ERDUNGSKLEMMEN! /
 No connection to the DIN rail!
 See grounding clamps!

Preise gültig ab 01.01.2018 exkl. MwSt., freibleibend, Auftragsrabatt auf Anfrage / prices are valid from 01.01.2018 excl. VAT, subject to change, discounts upon request
 sonst. Konditionen siehe www.gogatec.com/AGB.pdf, techn. Änderungen vorbehalten / terms & conditions can be found on our website: www.gogatec.com/AGB.pdf; error, technical modifications and variations are reserved

Aufschnappbar auf DIN-Hutschiene TS35 / snappable on DIN rail TS35

Isolierkörper / insulating part: Polyamid 6.6

Verbindungssteg / connecting web: Messing / brass

Zugbügelklemme und Schraube / box clamp and screw: Stahl verzinkt, gelb chromatisiert / galvanized steel, yellow chromated

Trennhebel / release lever: Kupferlegierung verzinkt / tinned copper alloy

Kriechstromfestigkeit / comparative tracking: IEC 112: CTI > 600, VDE 0303: KB > 600



GOGATEM EURO T - Nq2,5

Nennquerschnitt (mm ²) / nominal cross section	2,5	
Typ EURO	2,5/35	
Klemmenbreite (mm) / clamping width	5	
Flexible Leiter (mm ²) / flexible conductors	0,5-3,5	
Feste Leiter (mm ²) / solid conductors	0,5-4	
Leiter m. Aderendhülsen (mm ²) / cond. w. CES	0,5-2,5	
AWG	24-12	
Kaliber / caliber	A3	
Anz. anschließb. Leiter (mm ²) / numb. of. connectable cond.	2x1,5/4x1	
Leiterraufnahmeraum (mm) / connecting capacity	3,6x2,6	
Leiter abisolieren (mm) / stripping conductor	10	
Schraubengewinde / screwing thread	M2,6	
max. Anzugsdrehmoment (Nm) / max. tight. torque	0,5	
Normen / norms	SEV (mm ²)	2,5
	RINA (mm ²)	2,5
	VDE (mm ²)	2,5
	UL	AWG: 22-12
	CSA	AWG: 22-12

Typ	Abmessungen mm	VPE Stk.	ArtNr	€ /Stk.
type	dimensions	PU		/pc.
Nq2,5 Trenn T1	5 x 52 x 35	100	44-43439	1,86

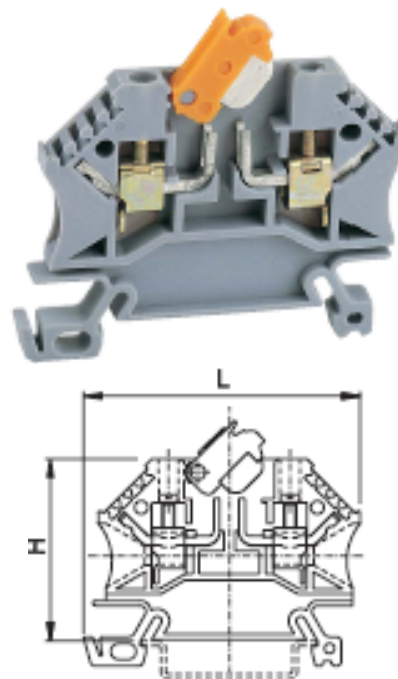

Preise gültig ab 01.01.2018 exkl. MwSt., freibleibend, Auftragsrabatt auf Anfrage /

prices are valid from 01.01.2018 excl. VAT, subject to change, discounts upon request

sonst. Konditionen siehe www.gogatec.com/AGB.pdf, techn. Änderungen vorbehalten /

terms & conditions can be found on our website: www.gogatec.com/AGB.pdf; error, technical modifications and variations are reserved

GOGATEM Endhalter Standard aufschraubbar / screwed standard end brackets

Material / material: Polyamid 6.6

Für Klemme <i>for clamp</i>	Abmessungen mm <i>dimensions</i>	VPE Stk. <i>PU</i>	ArtNr	€/Stk. <i>/pc.</i>
alle Klemmen / all clamps	58 x 36 x 9	50	44-43442	0,72

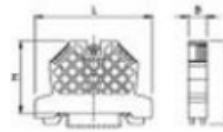

GOGATEM Endhalter schmal, aufschraubbar / end brackets small screwed

Für Klemme <i>for clamp</i>	Abmessungen mm <i>dimensions</i>	VPE Stk. <i>PU</i>	ArtNr	€/Stk. <i>/pc.</i>
alle Klemmen / all clamps	59 x 36 x 6	50	44-43444	0,58



GOGATEM Endhalter schmal, aufsnappbar / snappable small end brackets

Für Klemme <i>for clamp</i>	Abmessungen mm <i>dimensions</i>	VPE Stk. <i>PU</i>	ArtNr	€/Stk. <i>/pc.</i>
alle Klemmen / all clamps	60 x 36 x 6	50	44-43447	0,47



GOGATEM Endwinkel mit Beschriftungsplatte / end angle with inscription plate

Material / material: Polyamid 6.6

PKPA

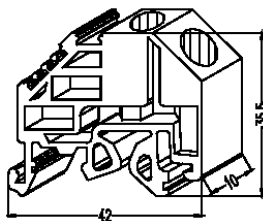

PKPA35

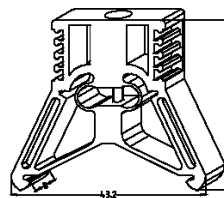

PKPA35N

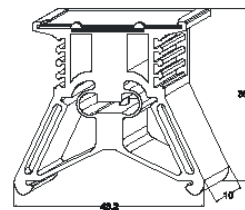

Typ <i>type</i>	Bemerkung <i>comment</i>	VPE Stk. <i>PU</i>	ArtNr	€/Stk. <i>/pc.</i>
PKPA 2,5-70	für Hut&C-Schiene / for DIN & C rail	50	61-PKPA	0,34
PKPA35	für Hutschiene / for DIN rail	50	61-PKPA35	0,32
PKPA35N	für Hutschiene / for DIN rail	1	61-PKPA35N	0,72

Preise gültig ab 01.01.2018 exkl. MwSt., freibleibend, Auftragsrabatt auf Anfrage /
prices are valid from 01.01.2018 excl. VAT, subject to change, discounts upon request
sonst. Konditionen siehe www.gogatec.com/AGB.pdf, techn. Änderungen vorbehalten /
terms & conditions can be found on our website: www.gogatec.com/AGB.pdf; error, technical modifications and variations are reserved

GOGATEM Abschlusswand / end wall

Material / material: Polyamid 6.6

Für Klemme <i>for clamp</i>	Abmessungen mm <i>dimensions</i>	VPE Stk. <i>PU</i>	ArtNr	€ /Stk. <i>/pc.</i>
Euro 2,5/35	44 x 35 x 1,5	100	44-43010	0,25
Euro 4/35	44 x 35 x 1,5	100	44-43010	0,25
Euro 6/35	50 x 43 x 1,5	100	44-43011	0,29
Euro 10/35	50 x 43 x 1,5	100	44-43011	0,29
Euro 16-25/35	56 x 48 x 1,5	50	44-43013	0,34
Euro 35-50/35	62 x 60 x 1,5	50	44-43014	0,41

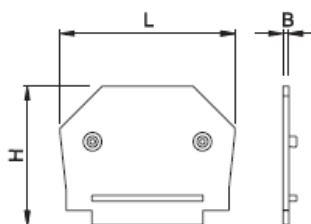

GOGATEM Trennwand / partition wall

Material / material: Polyamid 6.6

Für Klemme <i>for clamps</i>	Abmessungen mm <i>dimensions</i>	VPE Stk. <i>PU</i>	ArtNr	€ /Stk. <i>/pc.</i>
Euro 2,5/35	55 x 44 x 1,5	100	44-43015	0,31
Euro 4/35	44 x 35 x 1,5	100	44-43015	0,30
Euro 6/35	55 x 49 x 1,5	100	44-43016	0,35
Euro 10/35	55 x 49 x 1,5	100	44-43016	0,35

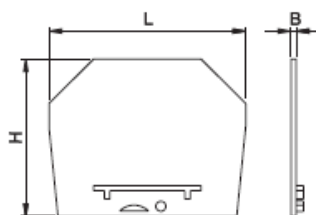

GOGATEM Klemmabdeckung / clamp cover

Material / material: Polycarbonat

Für Klemme <i>for clamp</i>	Abmessungen mm <i>dimensions</i>	VPE Stk. <i>PU</i>	ArtNr	€ /Stk. <i>/pc.</i>
Euro 2,5/35	47 x 24,5 x 4,8	100	44-43035	0,36
Euro 4/35	47 x 24,5 x 5,8	100	44-43030	0,35
Euro 6/35	53 x 26 x 6,8	100	44-43031	0,36
Euro 10/35	53 x 26 x 6,8	100	44-43031	0,36
Euro 16-25/35	59 x 26 x 11,5	50	44-43033	0,40
Euro 35-50/35	59 x 26 x 15,5	50	44-43034	0,47

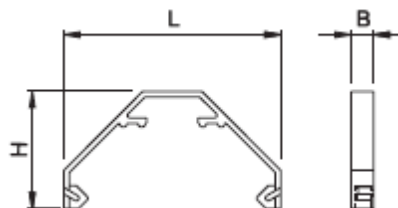

Preise gültig ab 01.01.2018 exkl. MwSt., freibleibend, Auftragsrabatt auf Anfrage /
prices are valid from 01.01.2018 excl. VAT, subject to change, discounts upon request
sonst. Konditionen siehe www.gogatec.com/AGB.pdf, techn. Änderungen vorbehalten /
terms & conditions can be found on our website: www.gogatec.com/AGB.pdf; error, technical modifications and variations are reserved

GOGATEM QVRJ2,5 Querverbindungsrechen für EURO 2,5 Q 2,5, X 2,5 / cross con. rakes

Typ	Pole	VPE Stk.	ArtNr	€ /Stk.
<i>type</i>	<i>poles</i>	<i>PU</i>		<i>/pc.</i>
QVRJ2,5-2	2	100	44-43525/02	37,31
QVRJ2,5-3	3	100	44-43525/03	53,00
QVRJ2,5-24	24	5	44-43525/24	21,70

GOGATEM QVRJ4 Querverbindungsrechen für EURO 4, 4/15, D4, Q4 / cross con. rakes

Typ	Pole	VPE Stk.	ArtNr	€ /Stk.
<i>type</i>	<i>poles</i>	<i>PU</i>		<i>/pc.</i>
QVRJ4-2	2	100	44-43520/02	37,31
QVRJ4-3	3	100	44-43520/03	52,50
QVRJ4-24	24	5	44-43520/24	21,68

GOGATEM QVRJ6 Querverbindungsrechen für EURO Q6 / cross con. rakes

Typ	Pole	VPE Stk.	ArtNr	€ /Stk.
<i>type</i>	<i>poles</i>	<i>PU</i>		<i>/pc.</i>
QVRJ6-2	2	100	44-43530/02	
QVRJ6-3	3	100	44-43530/03	37,00
QVRJ6-12	12	10	44-43530/12	

GOGATEM QVRJW-RDS2,5 Querverbindungsrechen für EURO W, WE, Z / cross con. rakes

Typ	Pole	VPE Stk.	ArtNr	€ /VPE
<i>type</i>	<i>poles</i>	<i>PU</i>		<i>/PU</i>
QVRJW2,5-2	2	100	44-43531/02RDS	a.A.
QVRJW2,5-3	3	100	44-43531/03RDS	a.A.
QVRJW2,5-12	12	10	44-43531/12RDS	a.A.



a.A. = auf Anfrage / upon request

GOGATEM QVRJW-BLS2,5 Querverbindungsrechen für EURO W, WE, Z / cross con. rakes

Typ	Pole	VPE Stk.	ArtNr	€ /VPE
<i>type</i>	<i>poles</i>	<i>PU</i>		<i>/PU</i>
QVRJW2,5-2	2	100	44-43531/02BLS	a.A.
QVRJW2,5-3	3	100	44-43531/03BLS	a.A.
QVRJW2,5-12	12	10	44-43531/12BLS	a.A.



a.A. = auf Anfrage / upon request

Preise gültig ab 01.01.2018 exkl. MwSt., freibleibend, Auftragsrabatt auf Anfrage /
 prices are valid from 01.01.2018 excl. VAT, subject to change, discounts upon request
 sonst. Konditionen siehe www.gogatec.com/AGB.pdf, techn. Änderungen vorbehalten /
 terms & conditions can be found on our website: www.gogatec.com/AGB.pdf; error, technical modifications and variations are reserved

GOGATEM SLS-QVRJ Schneidwerkzeug f. Querverbindungsrechen / cutting tool

Typ	Farbe	f. Verbindungsrechen	VPE	ArtNr	€
<i>type</i>	<i>color</i>	<i>for cross con. Rakes</i>	<i>Stk. PU</i>		<i>/Stk. /pc.</i>
SW-QVRJ2,5	orange / orange	QVRJ2,5	1	44-43515	57,70
SW-QVRJ4	gelb / yellow	QVRJ4	1	44-43516	57,70
SW-QVRJ6	grün / green	QVRJ6	1	44-43518	57,70



GOGATEM QVRJ6 Querverbindungsrechen für Klemmen EURO 6 / cross connection rakes

Typ	Pole	VPE	ArtNr	€
<i>type</i>	<i>poles</i>	<i>Stk. PU</i>		<i>/Stk. /pc.</i>
QVRJ6-2	2	50	44-43621/02	31,80
QVRJ6-3	3	50	44-43621/03	43,30
QVRJ6-24	24	5	44-43621/24	28,60



Preise gültig ab 01.01.2018 exkl. MwSt., freibleibend, Auftragsrabatt auf Anfrage /
prices are valid from 01.01.2018 excl. VAT, subject to change, discounts upon request
sonst. Konditionen siehe www.gogatec.com/AGB.pdf, techn. Änderungen vorbehalten /
terms & conditions can be found on our website: www.gogatec.com/AGB.pdf; error, technical modifications and variations are reserved

GOGATERM Querverbindungsrechen mit Schrauben / cross connection rakes with screws

Für Klemme <i>for clamp</i>	Schrauben <i>screws</i>	ArtNr	€ /Stk. /pc.
Euro 10/35 Art. Nr. 44-43402	55	44-43022/0.5MS	15,33
Euro 16-25/35 Art. Nr. 44-43403	41	44-43023/0.5MS	21,49
Euro 35-50/35 Art. Nr. 44-43404	32	44-43024/0.5MS	27,34
Euro 4/15 Art. Nr. 44-43420	82	44-43082/0.5MS	25,59

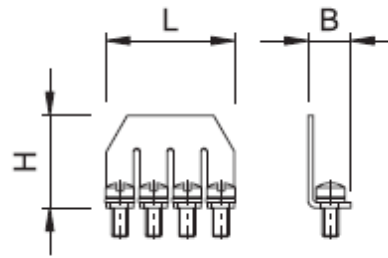

GOGATERM 1 Stück 2-polig + 2 Schrauben / 1 x 2-pole + 2 screws

Für Klemme <i>for clamp</i>	ArtNr	VPE Stk. /PU	€ /VPE /PU
Euro 10/35 Art. Nr. 44-43402	44-43022/2S	100	53,00
Euro 16-25/35 Art. Nr. 44-43403	44-43023/2S	50	46,85
Euro 35-50/35 Art. Nr. 44-43404	44-43024/2S	50	167,00
Euro 4/15 Art. Nr. 44-43420	44-43082/2S	100	63,00



GOGATERM 1 Stück 3-polig + 3 Schrauben / 1 x 3-pole + 3 screws

Für Klemme <i>for clamp</i>	ArtNr	VPE Stk. /PU	€ /VPE /PU
Euro 10/35 Art. Nr. 44-43402	44-43022/3S	100	78,00
Euro 16-25/35 Art. Nr. 44-43403	44-43023/3S	100	138,00
Euro 35-50/35 Art. Nr. 44-43404	44-43024/3S	50	124,00
Euro 4/15 Art. Nr. 44-43420	44-43082/3S	100	93,00



GOGATERM 1 Stück 4-polig + 4 Schrauben / 1 x 4-pole + 4 screws

Für Klemme <i>for clamp</i>	ArtNr	VPE Stk. /PU	€ /VPE /PU
Euro 10/35 Art. Nr. 44-43402	44-43022/4S	100	101,00
Euro 16-25/35 Art. Nr. 44-43403	44-43023/4S	100	186,00
Euro 35-50/35 Art. Nr. 44-43404	44-43024/4S	25	83,00
Euro 4/15 Art. Nr. 44-43420	44-43082/4S	100	123,00

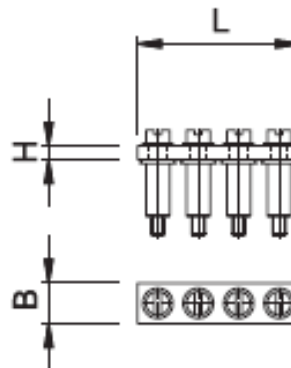

Preise gültig ab 01.01.2018 exkl. MwSt., freibleibend, Auftragsrabatt auf Anfrage /
prices are valid from 01.01.2018 excl. VAT, subject to change, discounts upon request
sonst. Konditionen siehe www.gogatec.com/AGB.pdf, techn. Änderungen vorbehalten /
terms & conditions can be found on our website: www.gogatec.com/AGB.pdf; error, technical modifications and variations are reserved

GOGATEM Prüfadapter rot / red test adapter

Material / material: Messing versilbert / silver plated brass

Für Klemme <i>for clamp</i>	Durchmesser mm <i>diameter</i>	VPE Stk. PU	ArtNr	€ /Stk. /pc.
Euro 4/35 Art. Nr. 44-43400	2,8	10	44-43926R	4,46
Euro 6/35 Art. Nr. 44-43401	2,8	10	44-43926R	4,46
Euro 10/35 Art. Nr. 44-43402	2,8	10	44-43926R	4,46

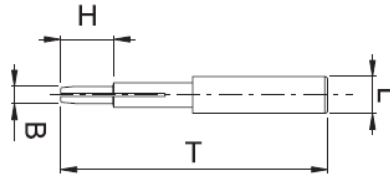

GOGATEM Prüfadapter schwarz / red test adapter

Material / material: Messing versilbert / silver plated brass

Für Klemme <i>for clamp</i>	Durchmesser mm <i>diameter</i>	VPE Stk. PU	ArtNr	€ /Stk. /pc.
Euro 4/35 Art. Nr. 44-43400	2,8	10	44-43926S	4,46
Euro 6/35 Art. Nr. 44-43401	2,8	10	44-43926S	4,46
Euro 10/35 Art. Nr. 44-43402	2,8	10	44-43926S	4,46

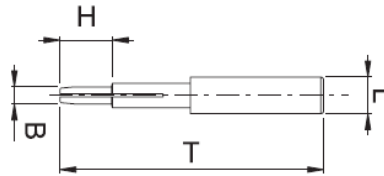

Preise gültig ab 01.01.2018 exkl. MwSt., freibleibend, Auftragsrabatt auf Anfrage /
prices are valid from 01.01.2018 excl. VAT, subject to change, discounts upon request
sonst. Konditionen siehe www.gogatec.com/AGB.pdf, techn. Änderungen vorbehalten /
terms & conditions can be found on our website: www.gogatec.com/AGB.pdf; error, technical modifications and variations are reserved