

M12 Steckverbinder für Schlauchanschluss / M12 plugging connectors for hose connection

Kontakte: Schraubklemmen /
contacts: screwing clamps

Kodierung / coding: A
Nennspannung / rating voltage: 4 Pole - 250 V; 5 Pole - 60 V
Nennstrom / rating current: 4 A
Temperaturbereich / temperature range: -40°C - +85°C
Isolationswiderstand / isolation resistance: $\geq 10^8 \Omega$
Kontaktwiderstand / contact resistance: $\leq 5m\Omega$
Mechanische Lebensdauer / mechanical lifespan: max. 100 Steckzyklen / max. 100 cycles
Schutzart / protection grade: IP67 nach / acc. to IEC 61076-2-101
Material Gehäuse / material housing: Polyamid / polyamide 66 GF25 /
Material Kontakt / material contact: Messing vernickelt / nickel plated brass
Kontaktoberfläche / contact surface: vergoldet / gold plated
Material Kontaktkörper / material contact body: PA
Material Dichtung / material sealing: Silikon / silicone

Schlauchanschluss möglich:
Druckschrauben entfernen und
Schlauchverschraubung einschrauben /
hose connection possible: remove pressure screw and
screw in hose fitting

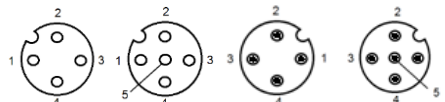

GOGAPLUG M12 Buchse gerade / straight M12 socket

Pole	max. Kabel Ø mm	Gew inde	ArtNr	€
pole	max. cable Ø	thread	part no.	/Stk. /pc.
4	4 - 6	PG7	34-W12F4A2-007-A	11,24
	6 - 8	PG9	34-W12F4A2-009-A	11,24
5	4 - 6	PG7	34-W12F5A2-007-A	a.A.
	6 - 8	PG9	34-W12F5A2-009-A	12,91

a. A. = auf Anfrage / upon request

GOGAPLUG M12 Stift gerade / straight M12 plug

Pole	max. Kabel Ø mm	Gew inde	ArtNr	€
pole	max. cable Ø	thread	part no.	/Stk. /pc.
4	4 - 6	PG7	34-W12M4A2-007-A	9,66
	6 - 8	PG9	34-W12M4A2-009-A	a.A.
5	4 - 6	PG7	34-W12M5A2-007-A	10,8
	6 - 8	PG9	34-W12M5A2-009-A	11,88

a. A. = auf Anfrage / upon request

GOGAPLUG M12 Buchse gewinkelt / angled M12 socket

Pole	max. Kabel Ø mm	Gew inde	ArtNr	€
pole	max. cable Ø	thread	part no.	/Stk. /pc.
4	4 - 6	PG7	34-W12F4B2-007-A	11,58
	6 - 8	PG9	34-W12F4B2-009-A	a.A.
5	4 - 6	PG7	34-W12F5B2-007-A	a.A.
	6 - 8	PG9	34-W12F5B2-009-A	13,21

a. A. = auf Anfrage / upon request

GOGAPLUG M12 Stift gewinkelt / angled M12 plug

Pole	max. Kabel Ø mm	Gew inde	ArtNr	€
pole	max. cable Ø	thread	part no.	/Stk. /pc.
4	4 - 6	PG7	34-W12M4B2-007-A	9,66
	6 - 8	PG9	34-W12M4B2-009-A	a.A.
5	4 - 6	PG7	34-W12M5B2-007-A	a.A.
	6 - 8	PG9	34-W12M5B2-009-A	11,24

a. A. = auf Anfrage / upon request

Passende Schlauchverschraubung / suitable hose fitting:

Typ	Länge mm	Gew inde- länge mm	Innen-Ø mm	Außen-Ø mm	Schlüssel- weite mm	VPE Stk.	ArtNr grau	ArtNr schwarz	€ /Stk. /pc.
type	length	thread length	inside-Ø	outside-Ø	spanner size	PU	grey	black	
PA-K1 PG7/7,5	24,3	7,0	8,5	15,2	14	50	245500	245500SW	1,34
PA-K1 PG9/7,5	26,1	7,3	8,4	17,3	14	50	245502	245502SW	1,37
PA-K1 PG9/10	28,0	7,6	10,5	19,8	19	50	245504	245504SW	1,37



Preise gültig ab 01.01.2023 exkl. MwSt., freibleibend, Auftragsrabatt auf Anfrage /

prices are valid from 01.01.2023 excl. VAT, subject to change, discounts upon request

sonst. Konditionen siehe www.gogatec.com/AGB.pdf, techn. Änderungen vorbehalten /

terms & conditions can be found on our website: www.gogatec.com/AGB.pdf; error, technical modifications and variations are reserved

M12 Steckverbinder für geschirmte Leitungen / plugging con. for shielded cables

Kodierung / coding: A

Anschlussart / connection: Schraubanschluss 0,75 mm²

Temperaturbereich / temperature range: -40°C - +85°C

Bemessungsspannung / rated voltage: 250 V

Bemessungs-Stoßspannung / rated impulse voltage: 2.500 V

Verschmutzungsgrad / pollution degree: 3

Überspannungskategorie / overvoltage category: II

Isolierstoffgruppe / isolation: II

Bemessungsstrom (40°C) / rated current (40°C): 4 A

Durchgangswiderstand / contact resistance: < 3 mΩ

EMV-Tauglichkeit / EMC: schirmbar / shieldable

Schutzart / protection class: IP 67, in verschraubtem Zustand / in locked position

Material Kontakt / material contact: CuZn (Messing / brass)

Kontaktoberfläche / contact surface: Au (Gold / gold)

Material Kontaktkörper / material contact body: PA

Mechanische Lebensdauer / mechanical life span: > 100 Steckzyklen / plugging cycles

Bussystem / bus system: auch für Device-Net und CAN geeignet / also suitable for Device-Net and CAN

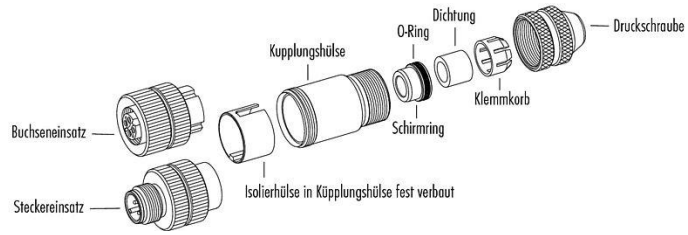

A-codiert /
A-coded

GOGAPLUG M12 Buchse geschirmt gerade / straight M12 socket shielded

Pole	Klemmbereich mm	ArtNr Schraubklemm	€ /Stk.	ArtNr Käfigzugfeder	€ /Stk.
pole	clamping range	screwing clamp	/pc.	spring clamp	/pc.
4	4 - 6	112F003	22,75	112F013	27,01
	6 - 8	112F004	22,75	112F014	27,01
5	4 - 6	112F005	25,66	112F015	30,87
	6 - 8	112F006	30,94	112F016	31,13
8	6 - 8	112F007	38,10	-	-
	8 - 10	112F008	41,51	-	-

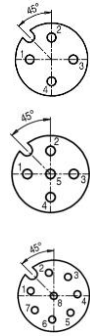
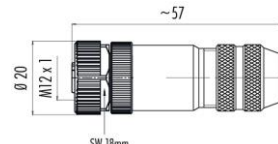

GOGAPLUG M12 Stift geschirmt gerade / straight M12 plug shielded

Pole	Klemmbereich mm	ArtNr Schraubklemm	€ /Stk.	ArtNr Käfigzugfeder	€ /Stk.
pole	clamping range	screwing clamp	/pc.	spring cage	/pc.
4	4 - 6	112F303	22,75	112F313	26,83
	6 - 8	112F304	22,75	112F314	26,83
5	4 - 6	112F305	25,23	112F315	31,13
	6 - 8	112F306	25,23	112F316	31,13
8	6 - 8	112F307	37,65	-	-
	8 - 10	112F308	41,06	-	-

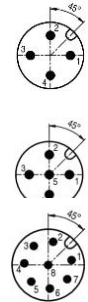
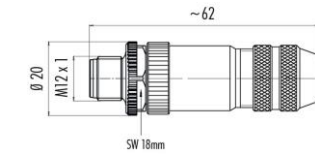

GOGAPLUG M12 Buchse gerade, Edelstahl / straight M12 socket, stainless steel

Pole	Kabeldurchlass mm	ArtNr Schraubklemme	€ /Stk.
pole	cable outlet	screwing clamp	/pc.
4	3 - 5,5	112V003	78,90
	5,5 - 8,6	112V004	83,50
5	3 - 5,5	112V005	83,50
	5,5 - 8,6	112V006	83,50
8	5,5 - 8,6	112V007	95,20



Edelstahlgehäuse /
stainless steel case

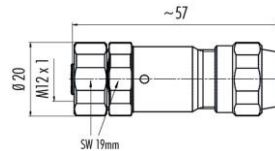

GOGAPLUG M12 Stift gerade, Edelstahl / straight M12 plug, stainless steel

Pole	Kabeldurchlass mm	ArtNr Schraubklemm	€ /Stk.
pole	cable outlet	screwing clamp	/pc.
4	3 - 5,5	112V303	78,40
	5,5 - 8,6	112V304	78,40
5	3 - 5,5	112V305	82,30
	5,5 - 8,6	112V306	82,30
8	5,5 - 8,6	112V307	94,70



Edelstahlgehäuse /
stainless steel case

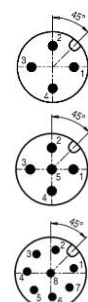
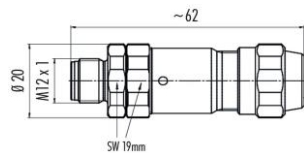

Preise gültig ab 01.01.2023 exkl. MwSt., freibleibend, Auftragsrabatt auf Anfrage /

prices are valid from 01.01.2023 excl. VAT, subject to change, discounts upon request

sonst. Konditionen siehe www.gogatec.com/AGB.pdf, techn. Änderungen vorbehalten /

terms & conditions can be found on our website: www.gogatec.com/AGB.pdf; error, technical modifications and variations are reserved

M12 Steckverbinder für geschirmte Leitungen / plugging con. for shielded cables



VENTILSTECKER
VALVE PLUGS

Kodierung / code: A

Anschluss / connection: Schraubanschluss 0,75 mm²

Temperaturbereich / temperature range: -40°C - +85°C

Bemessungsspannung / rated voltage: 250 V

Bemessungs-Stoßspannung / rated impulse voltage: 2.500 V

Verschmutzungsgrad / pollution degree: 3

Überspannungskategorie / overvoltage category: II

Isolierstoffgruppe / isolation: III

Bemessungsstrom (40°C) / rated current (40°C): 4 A

Durchgangswiderstand / contact resistance: < 3 mΩ

Schutzart / protection class: IP 67, in verschraubtem Zustand / in locked position

Material Kontakt / material contact: CuZn (Messing / brass)

Kontaktoberfläche / contact surface: Au (Gold / gold)

Material Kontaktkörper / material contact body: PA

Mechanische Lebensdauer / mechanical life span: > 50 Steckzyklen / plugging cycles

Bussystem / bus system: auch für Device-Net und CAN geeignet / also suitable for Device-Net and CAN

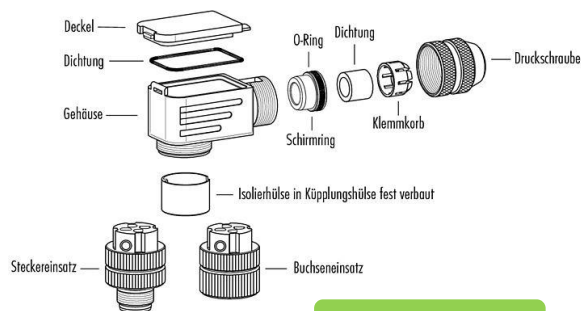

A-codiert / A-coded

GOGAPLUG M12 Buchse geschirmt gewinkelt / shielded angled M12 socket

EMV-Tauglichkeit / EMC: geschirmt / shielded

Pole	Klemmbereich mm	ArtNr Schraubklemm	€ /Stk.	ArtNr Käfigzugfeder	€ /Stk.
pole	clamping range	screwing clamp	/pc.	cage spring	/pc.
4	4 - 6	112F100	29,40	112F110	34,61
	6 - 8	112F101	29,40	112F111	34,61
5	4 - 6	112F102	33,26	112F112	38,47
	6 - 8	112F103	33,26	112F113	55,30

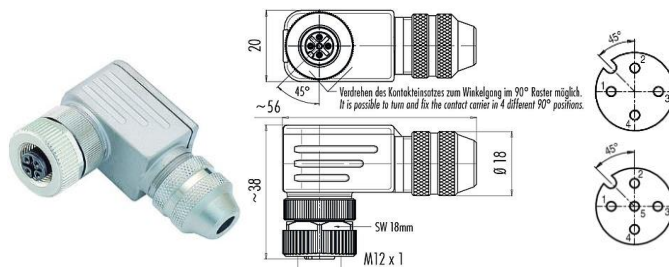

GOGAPLUG M12 Stift geschirmt gewinkelt / shielded angled M12 plug

EMV-Tauglichkeit / EMC: schirmbar / shieldable

Pole	Klemmbereich mm	ArtNr Schraubklemm	€ /Stk.	ArtNr Käfigzugfeder	€ /Stk.
pole	clamping range	screwing clamp	/pc.	cage spring	/pc.
4	4 - 6	112F500	29,26	112F510	34,13
	6 - 8	112F501	29,26	112F511	34,13
5	4 - 6	112F502	32,81	112F512	38,02
	6 - 8	112F503	32,81	112F513	38,02

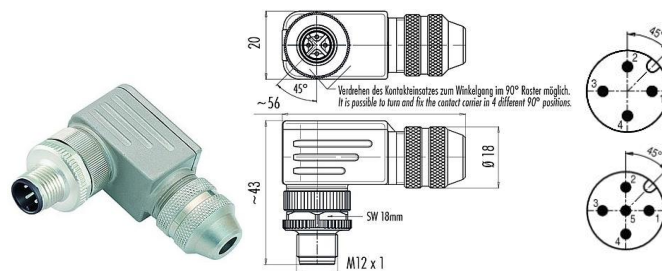

Preise gültig ab 01.01.2023 exkl. MwSt., freibleibend, Auftragsrabatt auf Anfrage /

prices are valid from 01.01.2023 excl. VAT, subject to change, discounts upon request

sonst. Konditionen siehe www.gogatec.com/AGB.pdf, techn. Änderungen vorbehalten /

terms & conditions can be found on our website: www.gogatec.com/AGB.pdf; error, technical modifications and variations are reserved

M12 Steckverbinder für Profibus & Interbus / plugging con. for profibus & interbus



VENTILSTECKER
VALVE PLUGS

Kodierung / code: B

Anschluss / connection: Schraubanschluss 0,75 mm²

Temperaturbereich / temperature range: -40°C - +85°C

Bemessungsspannung / rated voltage: 250 V

Bemessungs-Stoßspannung / rated impulse voltage: 2.500 V

Verschmutzungsgrad / pollution degree: 3

Überspannungskategorie / overvoltage category: II

Isolierstoffgruppe / isolation: III

Bemessungsstrom (40°C) / rated current (40°C): 4 A

Durchgangswiderstand / contact resistance: < 3 mΩ

EMV-Tauglichkeit / EMC: schirmbar / shieldable

Schutzart / protection class: IP 67, in verschraubtem Zustand / in locked position

Material Kontakt / material contact: CuZn (Messing / brass)

Kontaktoberfläche / contact surface: Au (Gold / gold)

Material Kontaktkörper / material contact body: PA

Mechanische Lebensdauer / mechanical life span: > 100 Steckzyklen / plugging cycles

Bussystem / bus system: Profibus, Interbus

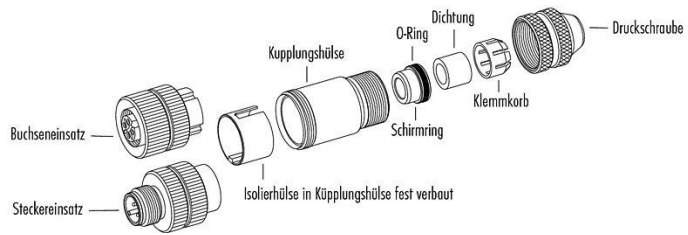

B-codiert / B-coded

GOGAPLUG M12 Buchse geschirmt gerade / shielded straight M12 socket

Pole	Klemmbereich mm	ArtNr Schraubklemm	€ /Stk.	ArtNr Käfigzugfeder	€ /Stk.
pole	clamping range	screwing clamp	/pc.	cage spring	/pc.
4	6 - 8	112F030	25,40	-	
	6 - 8	112F031	28,47	112F041	34,55
5	6,5 - 8,5	112F032	28,47	112F042	34,55
	8 - 10	112F033	33,85	-	

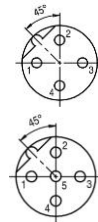
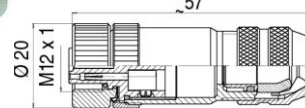

GOGAPLUG M12 Stift geschirmt gerade / shielded straight M12 plug

Pole	Klemmbereich mm	ArtNr Schraubklemm	€ /Stk.	ArtNr Käfigzugfeder	€ /Stk.
pole	clamping range	screwing clamp	/pc.	cage spring	/pc.
4	6 - 8	112F330	24,90	-	
	6 - 8	112F331	27,91	112F341	33,88
5	6,5 - 8,5	112F332	27,91	112F342	33,88
	8 - 10	112F333	33,20	-	

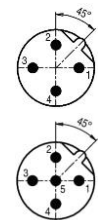
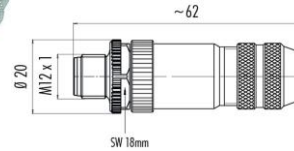

GOGAPLUG M12 Buchse gerade, Edelstahl / straight M12 socket, stainless steel

Pole	Klemmbereich mm	ArtNr Schraubklemm	€ /Stk.
pole	clamping range	screwing clamp	/pc.
4	5,5 - 8,6	112V030	82,30
5		112V031	92,20

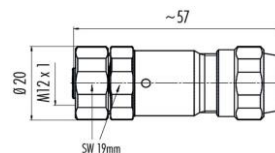

GOGAPLUG M12 Stift gerade, Edelstahl / straight M12 plug, stainless steel

Pole	Klemmbereich mm	ArtNr Schraubklemm	€ /Stk.
pole	clamping range	screwing clamp	/pc.
4	5,5 - 8,6	112V330	80,60
5		112V331	90,40

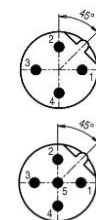
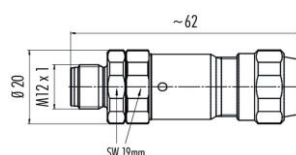

Preise gültig ab 01.01.2023 exkl. MwSt., freibleibend, Auftragsrabatt auf Anfrage /

prices are valid from 01.01.2023 excl. VAT, subject to change, discounts upon request

sonst. Konditionen siehe www.gogatec.com/AGB.pdf, techn. Änderungen vorbehalten /

terms & conditions can be found on our website: www.gogatec.com/AGB.pdf; error, technical modifications and variations are reserved

M12 Steckverbinder für Profibus & Interbus / plugging con. for profibus & interbus



VENTILSTECKER
VALVE PLUGS

Kodierung / code: B
Anschluss / connection: Schraubanschluss 0,75 mm²
Temperaturbereich / temperature range: -40°C - +85°C
Bemessungsspannung / rated voltage: 250 V
Bemessungs-Stoßspannung / rated impulse voltage: 2.500 V
Verschmutzungsgrad / pollution degree: 3
Überspannungskategorie / overvoltage category: II
Isolierstoffgruppe / isolation: II
Bemessungsstrom (40°C) / rated current (40°C): 4 A
Durchgangswiderstand / contact resistance: < 3 mΩ
EMV-Tauglichkeit / EMC: schirmbar / shieldable
Schutzart / protection class: IP 67, in verschraubtem Zustand / in locked position
Material Kontakt / material contact: CuZn (Messing / brass)
Kontaktoberfläche / contact surface: Au (Gold / gold)
Material Kontaktkörper / material contact body: PA
Mechanische Lebensdauer / mechanical life span: > 100 Steckzyklen / plugging cycles
Bussystem / bus system: Profibus, Interbus

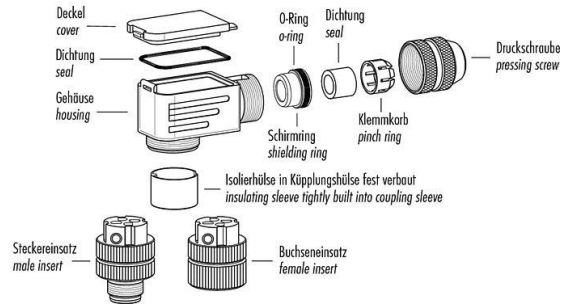

B-codiert / B-coded

GOGAPLUG M12 Buchse geschirmt gewinkelt / angled M12 socket shielded

Pole	Klemmbereich mm	ArtNr Schraubklemm	€ /Stk.	ArtNr Käfigzugfeder	€ /Stk.
<i>pole</i>	<i>clamping range</i>	<i>screwing clamp</i>	<i>/pc.</i>	<i>cage spring</i>	<i>/pc.</i>
4	6 - 8	112F130	31,24	-	
5	6 - 8	112F131	34,13	112F141	41,45
	6,5 - 8,5	112F132	34,13	112F142	41,45

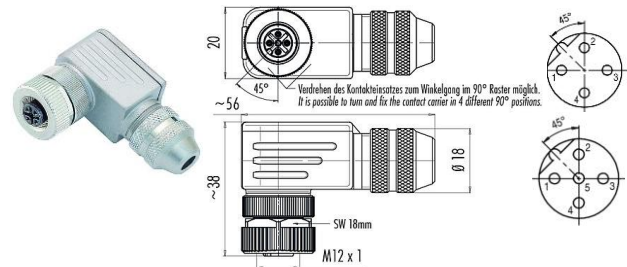

GOGAPLUG M12 Stift geschirmt gewinkelt / angled M12 plug shielded

Pole	Klemmbereich mm	ArtNr Schraubklemm	€ /Stk.	ArtNr Käfigzugfeder	€ /Stk.
<i>pole</i>	<i>clamping range</i>	<i>screwing clamp</i>	<i>/pc.</i>	<i>cage spring</i>	<i>/pc.</i>
4	6 - 8	112F530	31,24	-	
5	6 - 8	112F531	33,48	112F541	41,45
	6,5 - 8,5	112F532	33,48	112F542	41,45

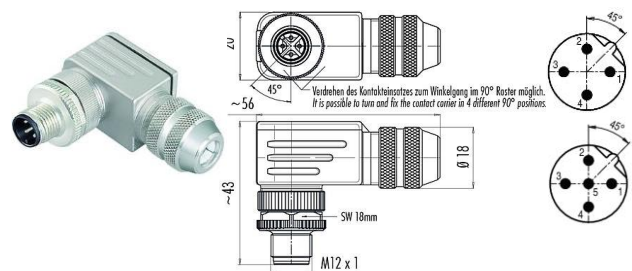

Preise gültig ab 01.01.2023 exkl. MwSt., freibleibend, Auftragsrabatt auf Anfrage /
 prices are valid from 01.01.2023 excl. VAT, subject to change, discounts upon request
 sonst. Konditionen siehe www.gogatec.com/AGB.pdf, techn. Änderungen vorbehalten /
 terms & conditions can be found on our website: www.gogatec.com/AGB.pdf; error, technical modifications and variations are reserved



M12 Steckverbinder für Ethernet, CAT.5e / plugging con. for ethernet, CAT.5e



VENTILSTECKER
VALVE PLUGS

Kodierung / code: D

Anschluss / connection: Schraubanschluss 0,75 mm²

Temperaturbereich / temperature range: -40°C - +85°C

Bemessungsspannung / rated voltage: 250 V

Bemessungs-Stoßspannung / rated impulse voltage: 2.500 V

Verschmutzungsgrad / pollution degree: 3

Überspannungskategorie / overvoltage category: II

Isolierstoffgruppe / isolation: III

Bemessungsstrom (40°C) / rated current (40°C): 4 A

Durchgangswiderstand / contact resistance: < 3 mΩ

EMV-Tauglichkeit / EMC: geschirmt / shielded

Schutzart / protection class: IP 67, in verschraubtem Zustand / in locked position

Material Kontakt / material contact: CuZn (Messing / brass)

Kontaktoberfläche / contact surface: Au (Gold / gold)

Material Kontaktkörper / material contact body: PA

Mechanische Lebensdauer / mechanical life span: > 100 Steckzyklen / plugging cycles

Bussystem / bus system: Ethernet, CAT.5e

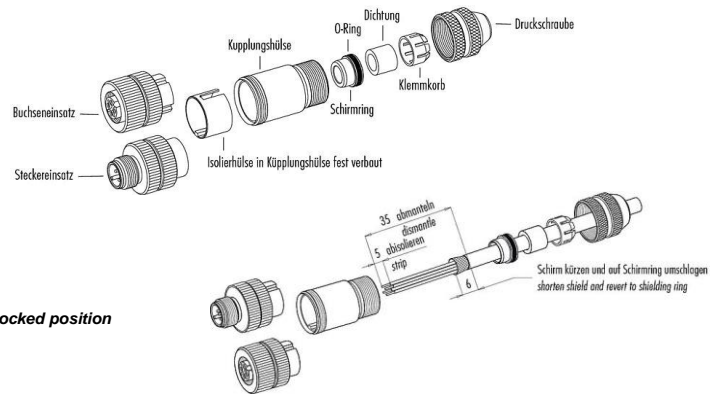

D-codiert / D-coded

GOGAPLUG M12 Buchse geschirmt gerade / straight M12 socket shielded

Pole	Klemmbereich mm	ArtNr Schraubklemme	€ /Stk.
pole	clamping range	screwing clamp	/pc.
4	6 - 8	112F060	24,42

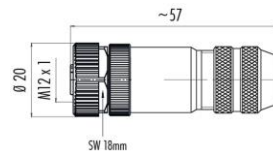

GOGAPLUG M12 Stift geschirmt gerade / straight M12 plug shielded

Pole	Klemmbereich mm	ArtNr Schraubklemme	€ /Stk.
pole	clamping range	screwing clamp	/pc.
4	6 - 8	112F360	25,94

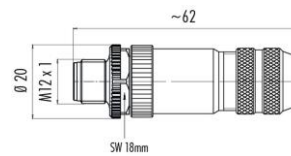

GOGAPLUG M12 Stift gerade, Edelstahl / straight M12 plug, stainless steel

Pole	Klemmbereich mm	ArtNr Schraubklemme	€ /Stk.
pole	clamping range	screwing clamp	/pc.
4	5,5 - 8,6	112V360	90,90

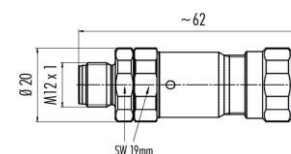

**Im Edelstahlgehäuse /
in stainless steel case**

Preise gültig ab 01.01.2023 exkl. MwSt., freibleibend, Auftragsrabatt auf Anfrage /

prices are valid from 01.01.2023 excl. VAT, subject to change, discounts upon request

sonst. Konditionen siehe www.gogatec.com/AGB.pdf, techn. Änderungen vorbehalten /

terms & conditions can be found on our website: www.gogatec.com/AGB.pdf; error, technical modifications and variations are reserved

M12 Steckverbinder für Ethernet, CAT.5e / plugging con. for ethernet, CAT.5e

Kodierung / coding: D
Anschluss / connection: Schraubanschluss 0,75 mm²
Temperaturbereich / temperature range: -40°C - +85°C
Bemessungsspannung / rated voltage: 250 V
Bemessungs-Stoßspannung / rated impulse voltage: 2.500 V
Verschmutzungsgrad / pollution degree: 3
Überspannungskategorie / overvoltage category: II
Isolierstoffgruppe / isolation: III
Bemessungsstrom (40°C) / rated current (40°C): 4 A
Durchgangswiderstand / contact resistance: < 3 mΩ
EMV-Tauglichkeit / EMC: geschirmt / shielded
Schutzart / protection class: IP 67, in verschraubtem Zustand / in locked position
Material Kontakt / material contact: CuZn (Messing / brass)
Kontaktoberfläche / contact surface: Au (Gold / gold)
Material Kontaktkörper / material contact body: PA
Mechanische Lebensdauer / mechanical life span: > 100 Steckzyklen / plugging cycles
Bussystem / bus system: Ethernet

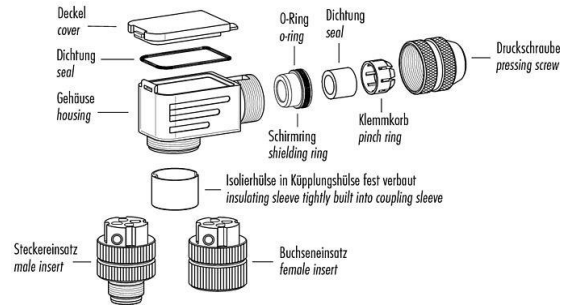
D-codiert / D-coded

GOGAPLUG M12 Buchse geschirmt gewinkelt / angled M12 socket shielded

Pole	Klemmbereich mm	ArtNr Schraubklemme	€ /Stk.
<i>pole</i>	<i>clamping range</i>	<i>screwing clamp</i>	<i>/pc.</i>
4	5,5 - 8,6	112F160	31,71

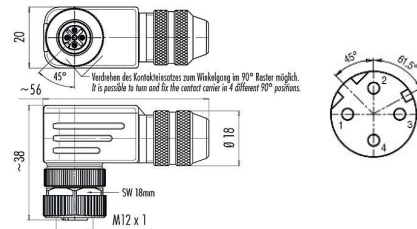

GOGAPLUG M12 Stift geschirmt gewinkelt / angled M12 plug shielded

Pole	Klemmbereich mm	ArtNr Schraubklemme	€ /Stk.
<i>pole</i>	<i>clamping range</i>	<i>screwing clamp</i>	<i>/pc.</i>
4	6 - 8	112F560	33,71

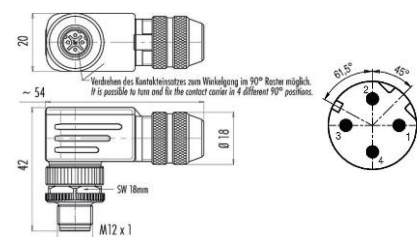

Preise gültig ab 01.01.2023 exkl. MwSt., freibleibend, Auftragsrabatt auf Anfrage /
 prices are valid from 01.01.2023 excl. VAT, subject to change, discounts upon request
 sonst. Konditionen siehe www.gogatec.com/AGB.pdf, techn. Änderungen vorbehalten /
 terms & conditions can be found on our website: www.gogatec.com/AGB.pdf; error, technical modifications and variations are reserved