

M8-Steckverbinder m. Anschlussleitung / M8 plugging connector w. connection cable



VENTILSTECKER
VALVE PLUGS

Material Gehäuse / material enclosure: PUR

Einsatz / insert: PA 6 V2 GW 750

Dichtung / sealing: Standard NBR (auch in Viton lieferbar) / standard NBR (also available in VITON)

Kontakte / contacts: CuZn 35 Pb2, C43500 (Messing), goldbeschichtet / CuZn35 Pb2, C43500 (brass), gold-plated

Schraubverschluss / screw: Selbstsichernde Hutmutter aus Messing vernickelt / plated self-locking nut made of brass

Spannung / voltage: 3-polig 60 V, 4-polig 30 V / 3-pole 60 V, 4-pole 30 V

Strom / current: 4A

Isolationswiderstand / isolation resistance: $\geq 10^9 \Omega$

Schutzart / protection grade: IP67

Steckzyklen / plugging cycles: max. 1.000

Mantelfarbe / coat color: schwarz

Norm / norm: EN 61076-2-101, DIN EN 50044

Typ PVC / type PVC

Material / material: Mantel PVC, Adern PVC / coat PVC, wires PVC

Temperaturbereich / temperature range: statisch / static -25°C - +70°C, bewegt / moving -5°C - +70°C

Typ PUR/PVC / type PUR/PVC

Material / material: Mantel PUR, Adern PVC / coat PUR, wires PVC

Temperaturbereich / temperature range: statisch / static -25°C - +80°C, bewegt / moving -5°C - +80°C

Auf Anfrage auch mit
UL-Zulassung erhältlich /
on request also with UL-certificate available

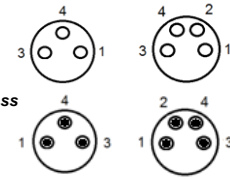

3 POLIG / 3-pole
4 POLIG / 4-pole

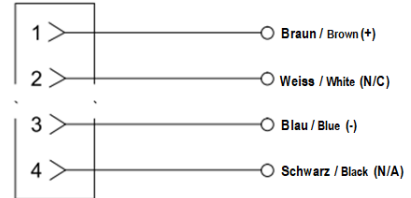
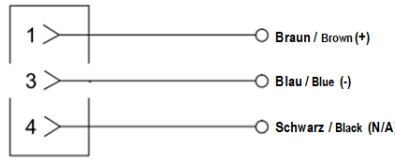

GOGAPLUG M8 Buchse gerade mit Anschlussleitung / straight M8 socket with connection cable

Type	Länge	Außen- ϕ	ArtNr	€	Außen- ϕ	ArtNr	€
Anz x mm ²	m	mm	PVC/PUR-Leitung	/Stk.	mm	PVC-Leitung	/Stk.
type	length	outer ϕ	PVC/PUR-wire	/pc.	outer ϕ	PVC-wire	/pc.
3 x 0,25	3	4,0 ± 0,2	34-C08F3A1-300-110	9,22	4,0 ± 0,2	34-C08F3A1-300-010	7,74
	5		34-C08F3A1-500-110	11,79		34-C08F3A1-500-010	9,32
	10		34-C08F3A1-10K-110	19,21		34-C08F3A1-10K-010	14,27
4 x 0,25	3	5,0 ± 0,2	34-C08F4A1-300-112	10,30	4,2 ± 0,2	34-C08F4A1-300-012	8,90
	5		34-C08F4A1-500-112	13,13		34-C08F4A1-500-012	10,80
	10		34-C08F4A1-10K-112	21,28		34-C08F4A1-10K-012	16,61

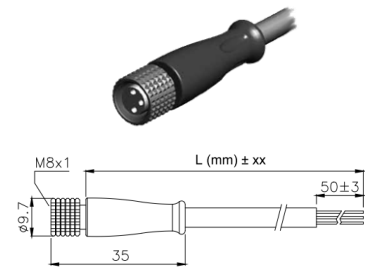

GOGAPLUG M8 Buchse gewinkelt mit Anschlussleitung / angled M8 socket w. connection cable

Type	Länge	Außen- ϕ	ArtNr	€	Außen- ϕ	ArtNr	€
Anz x mm ²	m	mm	PVC/PUR-Leitung	/Stk.	mm	PVC-Leitung	/Stk.
type	length	outer ϕ	PVC/PUR-wire	/pc.	outer ϕ	PVC-wire	/pc.
3 x 0,25	3	4,0 ± 0,2	34-C08F3B1-300-110	9,22	4,0 ± 0,2	34-C08F3B1-300-010	7,74
	5		34-C08F3B1-500-110	11,79		34-C08F3B1-500-010	9,32
	10		34-C08F3B1-10K-110	19,21		34-C08F3B1-10K-010	14,27
4 x 0,25	3	5,0 ± 0,2	34-C08F4B1-300-112	10,30	4,2 ± 0,2	34-C08F4B1-300-012	8,90
	5		34-C08F4B1-500-112	13,13		34-C08F4B1-500-012	10,80
	10		34-C08F4B1-10K-112	21,28		34-C08F4B1-10K-012	16,61

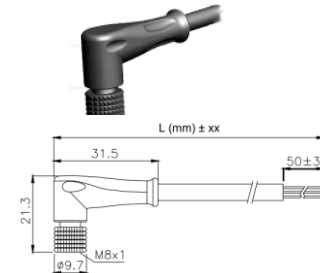

GOGAPLUG M8 Stift gerade mit Anschlussleitung / straight M8 plug with connection cable

Type	Länge	Außen- ϕ	ArtNr	€	Außen- ϕ	ArtNr	€
Anz x mm ²	m	mm	PVC/PUR-Leitung	/Stk.	mm	PVC-Leitung	/Stk.
type	length	outer ϕ	PVC/PUR-wire	/pc.	outer ϕ	PVC-wire	/pc.
3 x 0,25	3	4,0 ± 0,2	34-C08M3A1-300-110	9,63	4,0 ± 0,2	34-C08M3A1-300-010	8,15
	5		34-C08M3A1-500-110	12,20		34-C08M3A1-500-010	9,73
	10		34-C08M3A1-10K-110	19,68		34-C08M3A1-10K-010	14,74
4 x 0,25	3	5,0 ± 0,2	34-C08M4A1-300-112	10,66	4,2 ± 0,2	34-C08M4A1-300-012	9,26
	5		34-C08M4A1-500-112	13,55		34-C08M4A1-500-012	11,21
	10		34-C08M4A1-10K-112	21,65		34-C08M4A1-10K-012	16,98

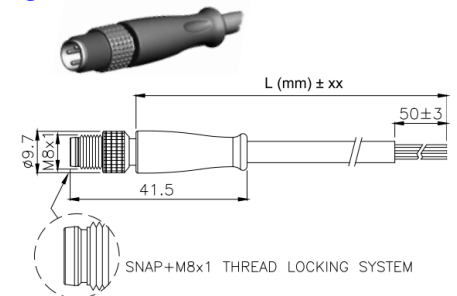

GOGAPLUG M8 Stift gewinkelt mit Anschlussleitung / angled M8 plug with connection cable

Type	Länge	Außen- ϕ	ArtNr	€	Außen- ϕ	ArtNr	€
Anz x mm ²	m	mm	PVC/PUR-Leitung	/Stk.	mm	PVC-Leitung	/Stk.
type	length	outer ϕ	PVC/PUR-wire	/pc.	outer ϕ	PVC-wire	/pc.
3 x 0,25	3	4,0 ± 0,2	34-C08M3B1-300-110	9,63	4,0 ± 0,2	34-C08M3B1-300-010	8,15
	5		34-C08M3B1-500-110	12,20		34-C08M3B1-500-010	9,73
	10		34-C08M3B1-10K-110	19,68		34-C08M3B1-10K-010	14,74
4 x 0,25	3	5,0 ± 0,2	34-C08M4B1-300-112	10,66	4,2 ± 0,2	34-C08M4B1-300-012	9,26
	5		34-C08M4B1-500-112	13,55		34-C08M4B1-500-012	11,21
	10		34-C08M4B1-10K-112	21,65		34-C08M4B1-10K-012	16,98

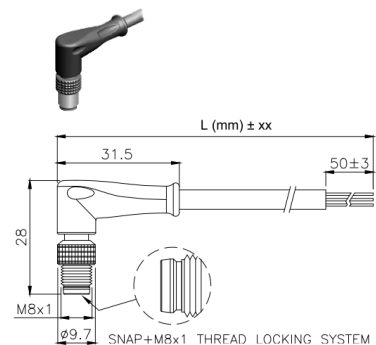

Preise gültig ab 01.01.2023 exkl. MwSt., freibleibend, Auftragsrabatt auf Anfrage /

prices are valid from 01.01.2023 excl. VAT, subject to change, discounts upon request

sonst. Konditionen siehe www.gogatec.com/AGB.pdf, techn. Änderungen vorbehalten /

terms & conditions can be found on our website: www.gogatec.com/AGB.pdf; error, technical modifications and variations are reserved