

### GOGATRAY Verbinder / connector



Nur 3 Teile / only 3 parts

Verschweißte Schraube / welded screw

Vereinfacht die Montage / simplifies mounting

Verbessert die mechanische Leistungsfähigkeit des Systems um 20 % / improves mechanical performance of the systems by 20%

Material	Gewicht kg/Stk.	VPE Stk.	ArtNr	€ /Stk.
material	weight	PU		/pc.
E.G.	0,027	50	06-64010061	0,82
BYCRO	0,026	50	06-64020061	a.A.
H.D.G.	0,026	50	06-64030061	1,24
S.S. 316	0,028	50	06-64060061	3,54

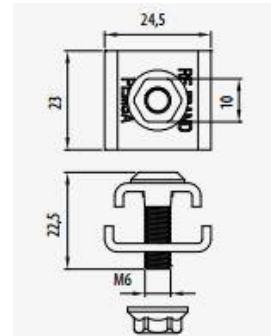

a. A. = auf Anfrage / upon request

### GOGATRAY Klemmstück / clamping piece

Zum Befestigen auf Konsolen und Profilen / to fix on consoles and profiles

H.D.G.\* Sonderausführung mit 6x30 Schraube für E90 Verlegung /

H.D.G. \* special version with 6 x 30 screw for E90 laying

Material	Gewicht kg/Stk.	VPE Stk.	ArtNr	€ /Stk.
material	weight	PU		/pc.
E.G.	0,016	50	06-64010060	0,62
BYCRO	0,016	50	06-64020060	0,68
H.D.G.	0,016	50	06-64030060	0,86
H.D.G.*	0,019	50	06-64030160	a.A.
S.S. 316	0,017	50	06-64060060	2,48

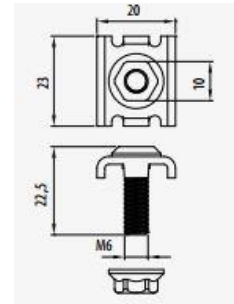

a. A. = auf Anfrage / upon request

### GOGATRAY Seiten-Schnellverbinder / side quick-connector

Click-Verbindung mit Bohrung zum direkten Befestigen / click connection with hole for direct mounting

Passend für 60 und 100 mm Höhe / suitable for 60 and 100mm height

Material	Gewicht kg/Stk.	VPE Stk.	ArtNr	€ /Stk.
material	weight	PU		/pc.
E.G.	0,016	50	06-64010035	2,84
H.D.G.	0,016	50	06-64030035	3,29

Breite mm	Anzahl
width	number
60	2
100	2
150	2
200	2
300	2
400	2
500	2
600	2

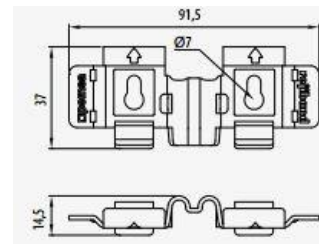
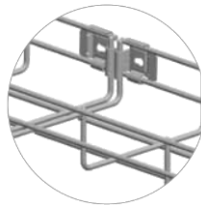

### GOGATRAY Boden-Schnellverbinder / bottom quick-connector

Click-Verbindung mit Bohrung zum direkten Befestigen / click connection with hole for direct mounting

Passend zu Seiten-Schnellverbinder / suitable for side quick-connector

Material	Gewicht kg/Stk.	VPE Stk.	ArtNr	€ /Stk.
material	weight	PU		/pc.
E.G.	0,016	50	06-64010036	2,89
BYCRO	0,016	50	06-64020036	3,36
H.D.G.	0,016	50	06-64030036	3,72

Breite mm	Anzahl
width	number
60	0
100	0
150	0
200	0
300	1
400	1
500	2
600	2

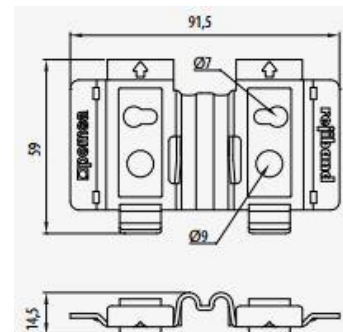
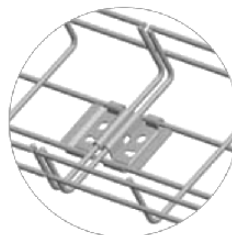

Preise gültig ab 01.01.2023 exkl. MwSt., freibleibend, Auftragsrabatt auf Anfrage /

prices are valid from 01.01.2023 excl. VAT, subject to change, discounts upon request

sonst. Konditionen siehe [www.gogatec.com/AGB.pdf](http://www.gogatec.com/AGB.pdf), techn. Änderungen vorbehalten /

terms & conditions can be found on our website: [www.gogatec.com/AGB.pdf](http://www.gogatec.com/AGB.pdf); error, technical modifications and variations are reserved

**GOGATRAY Gleitmutter GLM / slide nut**

Gleitmutter für Profile 41x21 u. 41x41 / slide nut for profiles 41x21 a. 41x41

Material	Gew inde	Gew icht	VPE	ArtNr	€
material	thread	kg/Stk.	Stk.		/Stk.
		weight	PU		/pc.
EG	M6	0,038		06-67020055	1,18
	M8	0,037		06-67010056	a.A.
HDG	M6	0,038		06-67030054	1,18
	M8	0,025	100	06-67030056	1,42
AISI316L	M6	0,038		06-67060054	3,10
	M8	0,037		06-67060056	6,02
	M10	0,035		06-67060058	5,81

a. A. = auf Anfrage / upon request

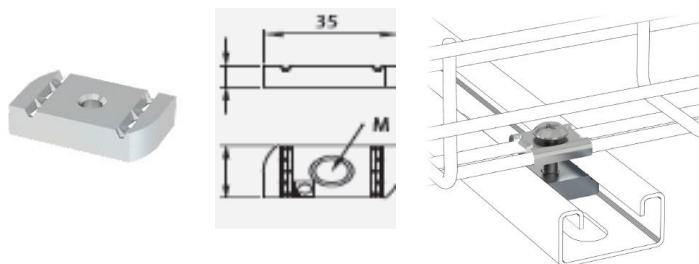

**GOGATRAY Verbindungslasche / connection plate**

Für Verbindungen und Befestigungen / for connections and mountings

Material	Gew icht	VPE	ArtNr	€
material	weight	PU		/pc.
E.G.	0,01	50	06-64010062	0,36
BYCRO	0,009	50	06-64020062	0,39
H.D.G.	0,01	50	06-64030062	0,45
S.S. 316	0,01	50	06-64060062	1,18

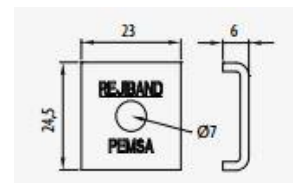

**GOGATRAY Erdungsklemme / earth clamp**

Material	Bauform	Gew icht	VPE	ArtNr	€
material	shape	kg/Stk.	Stk.		/pc.
		weight	PU		
Kupfer / copper	16-35	0,024	20	06-68000032	4,72
Kupfer / copper	35-50	0,024	20	06-68000033	6,24

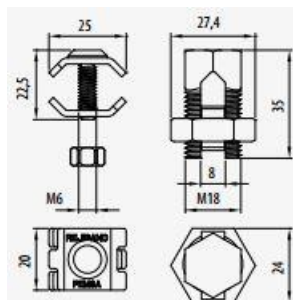
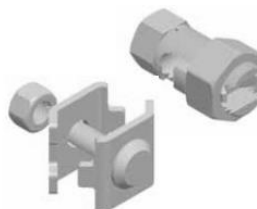

**GOGATRAY Kurven-Schnellverbinder / curve quick-connector**

Material	Gew icht	VPE	ArtNr	€
material	weight	PU		/pc.
E.G.	0,036	50	06-64010072	0,88
BYCHRO	0,036	50	06-64020072	0,88
H.D.G.	0,036	50	06-64030072	1,20

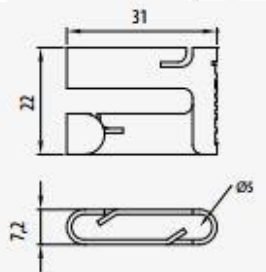

**GOGATRAY Mehrfachverbinder / multi-connector**

Material	Gew icht	VPE	ArtNr	€
material	weight	PU		/pc.
E.G.	0,065	10	06-67010053	2,94
BYCRO	0,065	10	06-67020053	2,94
H.D.G.	0,069	10	06-67030047	3,47
S.S. 316	0,6064	10	06-67060053	7,72

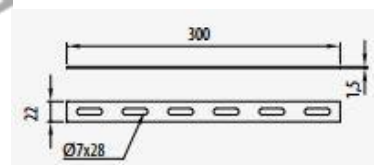

**Materialien und Korrosionsbeständigkeit (nach BS-EN 61537) / Materials and corrosion resistance (according to BS EN 61537):**

Material	Materialbezeichnung	Beständig/h
material	material	resistant/h
P.G.	Senzimirkalvanisiert nach / senzimir galvanized to UNE EN 10346	190
E.G.	Elektrokalvanisiert nach / electro galvanized to BS-EN ISO 2081	190
BYCRO	Verzinkt und bichromatiert nach / galvanied and bichromated to BS-EN ISO 2081	440
H.D.G.	Feuerverzinkt nach / hot-dip galvanized to BS-EN ISO 10346	660
S.S. 304	Edelstahl / stainless steel AISI 304	>850
S.S. 316	Edelstahl / stainless steel AISI 316	>850

Preise gültig ab 01.01.2023 exkl. MwSt., freibleibend, Auftragsrabatt auf Anfrage /

prices are valid from 01.01.2023 excl. VAT, subject to change, discounts upon request

sonst. Konditionen siehe [www.gogatec.com/AGB.pdf](http://www.gogatec.com/AGB.pdf), techn. Änderungen vorbehalten /

terms & conditions can be found on our website: [www.gogatec.com/AGB.pdf](http://www.gogatec.com/AGB.pdf); error, technical modifications and variations are reserved

**GOGATRAY Click-Verbinder / click-connector**

Schnelle Montage / fast mounting

Ohne Schrauben / without screws

Ohne besondere Vorrichtungen / without special equipment

Garantie der elektrischen Verbindung / guarantee of electrical connection

Material	Gewicht kg/Stk.	VPE Stk.	ArtNr	€/Stk.
material	weight	PU		/pc.
E.G.	0,072	25	06-64010020	2,09
BYCRO	0,072	25	06-64020030	2,09

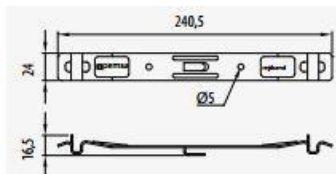

**GOGATRAY Universal Montageplatte / mounting plate**

Material	Gewicht kg/Stk.	VPE Stk.	ArtNr	€/Stk.
material	weight	PU		/pc.
P.G.	0,169	10	06-62026011	3,51
H.D.G.	0,182	10	06-62036011	6,34
S.S. 316	0,176	10	06-62066011	20,11

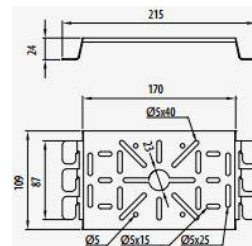
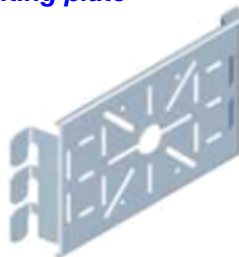

**GOGATRAY Flanschplatte f. Schlauchverschraubung / flange for hose gland**

Bohrungen / holes: 2x12 mm, 2x16mm, 1x20mm, 1x25mm 1x29mm

Material	Gewicht kg/Stk.	VPE Stk.	ArtNr	€/Stk.
material	weight	PU		/pc.
E.G.	0,063	10	06-67010040	2,92
BYCRO	0,063	10	06-67020040	3,13

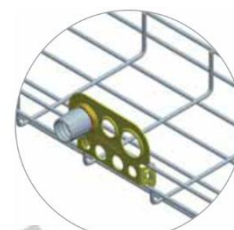

**GOGATRAY Seitenverbindungsplatte / side connector**

Material	Gewicht kg/Stk.	VPE Stk.	ArtNr	€/Stk.
material	weight	PU		/pc.
E.G.	0,048	50	06-64010041	1,27
BYCRO	0,048	50	06-64020041	1,54
H.D.G.	0,05	50	06-64030041	1,57
S.S. 316	0,048	50	06-64060041	4,41

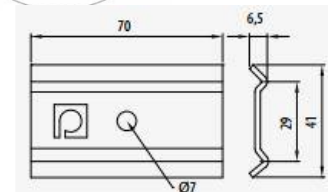

**GOGATRAY Glasfaser-Kabelabgang / fiber cable outlet**

zur Vermeidung von Kabelknicken / to avoid cable kinking

Material	Gewicht kg/Stk.	VPE Stk.	ArtNr	€/Stk.
material	weight	PU		/pc.
Kunststoff / plastic	0,011	10	06-67020039	2,83



**GOGATRAY Abschluss-Kappe / end cap**

zur Vermeidung von Verletzungen / to avoid injuries

Material	Gewicht kg/Stk.	VPE Stk.	ArtNr	€/Stk.
material	weight	PU		/pc.
PE schwarz / black	0,001	100	06-68000049	0,48

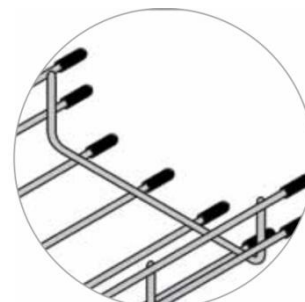
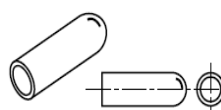

Preise gültig ab 01.01.2023 exkl. MwSt., freibleibend, Auftragsrabatt auf Anfrage /

prices are valid from 01.01.2023 excl. VAT, subject to change, discounts upon request

sonst. Konditionen siehe [www.gogatec.com/AGB.pdf](http://www.gogatec.com/AGB.pdf), techn. Änderungen vorbehalten /

terms & conditions can be found on our website: [www.gogatec.com/AGB.pdf](http://www.gogatec.com/AGB.pdf); error, technical modifications and variations are reserved

### GOGATRAY Zinkfarbe / zinc paint

zur Rostvermeidung bei Schnittstellen / for rust prevention at interfaces

Typ	Gewicht	VPE	ArtNr	€
kg/Stk.	Stk.	/Stk.		
type	weight	PU		/pc.
Spray	0,52	1	06-68000052	29,39



### GOGATRAY Bolzenschneider / bolt cutters

mit asymmetrischen Schneidekanten / with asymmetrical cutting edges

Typ	Gewicht	VPE	ArtNr	€	
A	kg/Stk.	Stk.		/Stk.	
type	weight	PU		/pc.	
Werkzeug / tool	450	1,6	1	06-68000058	62,30



### GOGATRAY Schild für Trennsteg / shield for seperating web

zur Kennzeichnung der Stromkreise / for the identification of circuits

Material	Gewicht	VPE	ArtNr	€
kg/Stk.	Stk.	/Stk.		/Stk.
material	weight	PU		/pc.
Kunststoff / plastic	0,002	50	06-68000020	0,80

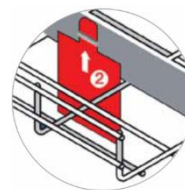

### GOGATRAY Rejifix Klettband / velcro

Preiswert und wiederverwendbar / inexpensive and reusable

Keine Schrauben notwendig / no screws necessary

Hergestellt aus brandhemmendem Material / made of fire retardant material

Material	Gewicht	Länge	Farbe	VPE	ArtNr	€
kg	m		Stk.		/Stk.	
material	weight	length	colour	PU		/pc.
Klettband / velcro	0,14	25	schwarz / black	1	06-89011000	a.A.

a. A. = auf Anfrage / upon request

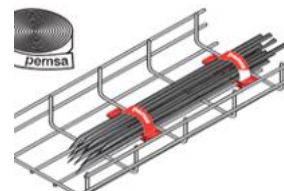

### GOGATRAY Montagehalter für Klettband / holder for velcro

Material	Gewicht	VPE	ArtNr	€
kg/Stk.	Stk.	/Stk.		/Stk.
material	weight	PU		/pc.
ABS	0,008	20	06-68000010	1,21

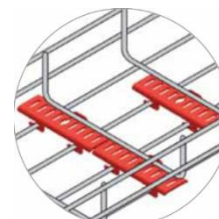

### GOGATRAY Gehäuse Halterung / case holder

Preiswert - Keine Schrauben notwendig / inexpensive - no screws necessary

Effizient isoliert / efficient insulated

Material	Gewicht	VPE	ArtNr	€
kg/u	Stk.	/Stk.		/Stk.
material	weight	PU		/pc.
Kunststoff / plastic	0,01	20	06-68000040	0,80

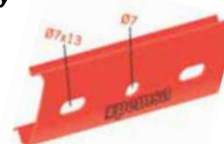

### GOGATRAY Leuchten und Gehäuse Halterung / case and light holder

Material	Gewicht	VPE	ArtNr	€
kg/Stk.	Stk.	/Stk.		/Stk.
material	weight	PU		/pc.
BYCHRO	0,008	8	06-67020030	5,39
H.D.G.	0,008	8	06-67030030	6,39



### GOGATRAY Kennzeichnungsschild / marking shield

für seitliche Montage / for side mounting

Material	Gewicht	VPE	ArtNr	€
kg/Stk.	Stk.	/Stk.		/Stk.
material	weight	PU		/pc.
Polypropylen	0,1	50	06-69000400	0,92



Preise gültig ab 01.01.2023 exkl. MwSt., freibleibend, Auftragsrabatt auf Anfrage (ausgenommen NETTOPREISE bei Werkzeugen)  
prices are valid from 01.01.2023 excl. VAT, subject to change, discounts upon request (excluding NET PRICES by tools)  
sonst. Konditionen siehe [www.gogatec.com/AGB.pdf](http://www.gogatec.com/AGB.pdf), techn. Änderungen vorbehalten /  
terms & conditions can be found on our website: [www.gogatec.com/AGB.pdf](http://www.gogatec.com/AGB.pdf); error, technical modifications and variations are reserved

GOGATRAY Deckel / cover

Material	A	Gewicht		VPE	ArtNr	€/m.
		kg/Stk.	Stk.			
material		weight	PU			
P.G.	60	0,47	24	06-73021060	4,69	
	100	0,74	24	06-73021100	5,40	
	150	1,02	12	06-73021150	7,08	
	200	1,3	12	06-73021200	8,76	
	300	2,11	6	06-73021300	12,91	
	400	2,74	6	06-73021400	18,63	
	500	4,22	6	06-73021500	24,44	
	600	5,01	6	06-73021600	30,45	
H.D.G.	60	0,62	24	06-73031060	8,40	
	100	0,84	24	06-73031100	10,38	
	150	1,14	12	06-73031150	15,24	
	200	1,6	12	06-73031200	18,16	
	300	2,3	6	06-73031300	26,68	
	400	3,68	6	06-73031400	39,41	
	500	4,54	6	06-73031500	50,60	
	600	5,39	6	06-73031600	59,90	
S.S.316	60	0,62	24	06-73061060	32,34	
	100	0,85	24	06-73061100	42,59	
	150	1,16	12	06-73061150	55,60	
	200	1,48	12	06-73061200	68,60	
	300	2,11	6	06-73061300	93,30	
	400	2,74	6	06-73061400	120,50	
	500	3,37	6	06-73061500	146,30	
	600	4	6	06-73061600	206,00	

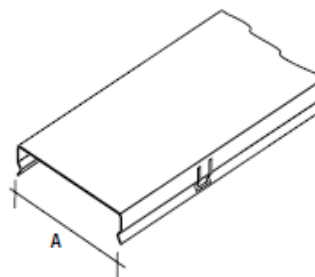

GOGATRAY Trennsteg / divider

Material	A	Gewicht		VPE	ArtNr	€/m.
		kg/Stk.	Stk.			
material		weight	PU			
P.G.	25	0,26	60	06-67020610	4,04	
	50	0,38	48	06-67020611	4,66	
	80	0,53	36	06-67020612	6,58	
H.D.G.	25	0,3	60	06-67030610	5,84	
	50	0,43	48	06-67030611	7,02	
	80	0,6	36	06-67030612	10,82	
S.S. 316	25	0,26	60	06-67060610	32,10	
	50	0,38	48	06-67060611	40,44	
	80	0,53	36	06-67060612	55,30	

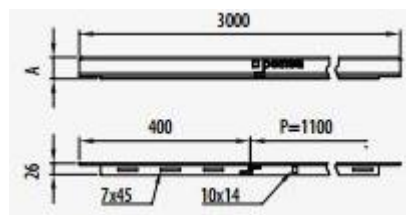

Materialien und Korrosionsbeständigkeit (nach BS-EN 61537):  
Materials and corrosion resistance (according to BS EN 61537):

Material	Materialbezeichnung	Beständig/h
material	material	resistant/h
P.G.	Sendzimirgalvanisiert nach / sendzimir galvanized to UNE EN 10346	190
H.D.G.	Feuerverzinkt nach / hot-dip galvanized to BS-EN ISO 10346	660
S.S. 316	Edelstahl / stainless steel AISI 316	>850

Preise gültig ab 01.01.2023 exkl. MwSt., freibleibend, Auftragsrabatt auf Anfrage /  
prices are valid from 01.01.2023 excl. VAT, subject to change, discounts upon request  
sonst. Konditionen siehe [www.gogatec.com/AGB.pdf](http://www.gogatec.com/AGB.pdf), techn. Änderungen vorbehalten /  
terms & conditions can be found on our website: [www.gogatec.com/AGB.pdf](http://www.gogatec.com/AGB.pdf); error, technical modifications and variations are reserved