

Passende Werkzeuge siehe GOGATOOL Katalog / *for appropriate tools please see GOGATOOL catalog*

**GOGAPIN KKSE-FH Flachsteckhülse unisoliert /  
*unsulated female disconnects***

Material / *material*: E-CU gal Sn

Normen / *standards*: DIN 46247, DIN 46330 Teil 2 und ähnliche Ausführungen / *and similar types*

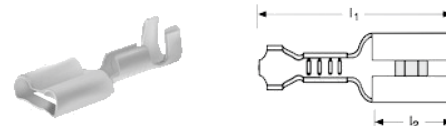

Typ <i>type</i>	Bereich <i>mm² range</i>	Steckbreite <i>mm tab-width</i>	Steckdicke <i>mm tab-thickness</i>	Abmessungen mm <i>dimensions mm</i>		Gewicht/100Stk. <i>kg weight / 100 pcs.</i>	VPE <i>Stk. PU</i>	ArtNr	€/100 Stk. <i>/100 pcs.</i>
				l1	l2				
KKSE-FH-1,5-2805		2,8	0,5	12,5	5,0	0,02		12105000152805	3,82
KKSE-FH-1,5-2808		2,8	0,8	12,5	5,0	0,023		12105000152808	5,14
KKSE-FH-1,5-4805	0,5-1,5	4,8	0,5	15,6	6,0	0,05	100	12105000154805	5,98
KKSE-FH-1,5-4808		4,8	0,8	15,6	6,0	0,05		12105000154808	6,04
KKSE-FH-1,5-6308		6,3	0,8	19,0	7,4	0,082		12105000156308	7,73
KKSE-FH-2,5-4805		4,8	0,5	16,0	6,3	0,054		12105000254805	12,80
KKSE-FH-2,5-4808	1,5-2,5	4,8	0,8	16,0	6,3	0,054	100	12105000254808	10,09
KKSE-FH-2,5-6308		6,3	0,8	19,2	7,6	0,092		12105000256308	8,46
KKSE-FH-6-6308	4-6	6,3	0,8	19,2	7,6	0,096	100	12105000606308	21,12

**GOGAPIN KSE-FHRZ mit Rastzunge unisoliert /  
*unsulated female disconnects with retaining snap***

Material / *material*: E-CU gal Sn

Normen / *standards*: DIN 46340 Teil 1-4 und ähnliche Ausführungen / *and similar types*

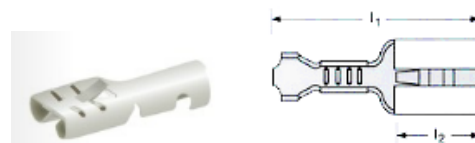

Typ <i>type</i>	Bereich <i>mm² range</i>	Steckbreite <i>mm tab-width</i>	Steckdicke <i>mm tab-thickness</i>	Abmessungen mm <i>dimensions mm</i>		Gewicht/100Stk. <i>kg weight / 100 pcs.</i>	VPE <i>Stk. PU</i>	ArtNr	€/100 Stk. <i>/100 pcs.</i>
				l1	l2				
KKSE-FHRZ-1,5-2808		2,8	0,8	14,0	6,3	0,025		12105200152808	41,15
KKSE-FHRZ-1,5-4805	0,5-1,5	4,8	0,5	15,6	6,0	0,05	100	12105200154805	18,66
KKSE-FHRZ-1,5-4808		4,8	0,8	15,6	6,0	0,05		12105200154808	17,66
KKSE-FHRZ-1,5-6308		6,3	0,8	19,2	7,4	0,08		12105200156308	9,07
KKSE-FHRZ-2,5-4805		4,8	0,5	15,6	6,0	0,053		12105200254805	a.A.
KKSE-FHRZ-2,5-4808	1,5-2,5	4,8	0,8	15,6	6,0	0,054	100	12105200254808	22,49
KKSE-FHRZ-2,5-6308		6,3	0,8	19,2	7,4	0,085		12105200256308	7,94
KKSE-FHRZ-2,5-6308-V*		6,3	0,8	19,2	7,4	0,085		12105200256308V	37,03
KKSE-FHRZ-6-6308	4-6	6,3	0,8	19,2	7,4	0,09	100	12105200606308	24,59

a. A. = auf Anfrage / *upon request*

\*V = vibrationsicher verriegelbar / *vibration-proof lockable*

**GOGAPIN KKSE-FH90 m. seitlichen Leiteranschluss unisoliert /  
*unsulated female disconnects flag-type***

Material / *material*: E-CU gal Sn

Normen / *standards*: DIN 46346 Form A und ähnliche Ausführungen / *and similar types*



Typ <i>type</i>	Bereich <i>mm² range</i>	Steckbreite <i>mm tab-width</i>	Steckdicke <i>mm tab-thickness</i>	Abmessungen mm <i>dimensions mm</i>		Gewicht/100Stk. <i>kg weight / 100 pcs.</i>	VPE <i>Stk. PU</i>	ArtNr	€/100 Stk. <i>/100 pcs.</i>
				l1	l2				
KKSE-FH90-1-2805		2,8	0,5	7,85	5,0	0,027		12105800102805	19,81
KKSE-FH90-1-2808	0,5-1,0	2,8	0,8	7,85	5,0	0,027	100	12105800102808	30,20
KKSE-FH90-1-6308		6,3	0,8	12,50	7,4	0,081		12105800106308	14,84
KKSE-FH90-2,5-6308	1,5-2,5	6,3	0,8	15,00	8,5	0,087	100	12105800256308	24,87
KKSE-FH90-6-9508	2,5-4,0	9,5	1,2	18,50	12,0	0,28	100	12105800609508	a.A.

a. A. = auf Anfrage / *upon request*

**GOGAPIN KKSE-FHA FH mit Abzweig unisoliert /  
*unsulated piggy back disconnects***

Material / *material*: E-CU gal Sn

Normen / *standards*: DIN 46345

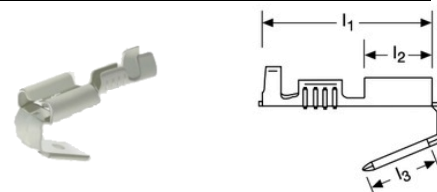

Typ <i>type</i>	Bereich <i>mm² range</i>	Steckbreite <i>mm tab-width</i>	Steckdicke <i>mm tab-thickness</i>	Abmessungen mm <i>dimensions mm</i>			Gewicht/100Stk. <i>kg weight / 100 pcs.</i>	VPE <i>Stk. PU</i>	ArtNr	€/100 Stk. <i>/100 pcs.</i>
				l1	l2	l3				
KKSE-FHA-1,5-4808	0,5-1,0	4,8	0,8	15,6	6,0	7,0	0,068	100	12106000104808	27,14
KKSE-FHA-1,5-6308		6,3	0,8	19,0	7,7	8,0	0,112		12106000106308	16,53
KKSE-FHA-2,5-4808	1,5-2,5	4,8	0,8	15,6	6,0	7,0	0,07	100	12106000254808	36,40
KKSE-FHA-2,5-6308		6,3	0,8	19,0	7,7	8,0	0,114		12106000256308	16,77

Preise gültig ab 01.01.2023 exkl. MwSt., freibleibend, Auftragsrabatt auf Anfrage /

*prices are valid from 01.01.2023 excl. VAT, subject to change, discounts upon request*

sonst. Konditionen siehe [www.gogatec.com/AGB.pdf](http://www.gogatec.com/AGB.pdf), techn. Änderungen vorbehalten /

*terms & conditions can be found on our website: www.gogatec.com/AGB.pdf; error, technical modifications and variations are reserved*

Passende Werkzeuge siehe GOGATOOL Katalog / *for appropriate tools please see GOGATOOL catalog*

**GOGAPIN KKSE-FS Flachstecker unisoliert /  
*uninsulated male disconnects***

**Material / material:** E-CU gal Sn  
**Normen / standards:** DIN 46248, DIN 46343 und ähnliche Ausführungen / *and similar types*

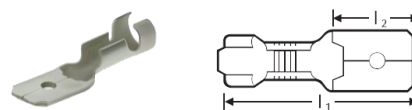

Typ <i>type</i>	Bereich mm <sup>2</sup> <i>range</i>	Steckbreite mm <i>tab-width</i>	Steckdicke mm <i>tab-thickness</i>	Abmessungen mm <i>dimensions mm</i>		Gewicht/100Stk. kg <i>/100 pcs.</i>	VPE Stk. <i>PU</i>	ArtNr	€ /100 Stk. <i>/100 pcs.</i>
				l1	l2				
KKSE-FS-1,5-2808	0,5-1,5	2,8	0,8	12,6	5,5	0,038	100	12104000152808	a.A.
KKSE-FS-1,5-6308		6,3	0,8	21,7	11,4	0,048		12104000156308	17,03
KKSE-FS-2,5-6308	1,5-2,5	6,3	0,8	20,0	8,8	0,058	100	12104000256308	16,94
KKSE-FS-6-6308	4-6	6,3	0,8	20,0	8,8	0,085	100	12104000606308	52,70

a. A. = auf Anfrage / *upon request*

**GOGAPIN KKSE-FSRZ mit Rastzunge unisoliert /  
*uninsulated male disconnects with retaining snap***

**Material / material:** E-CU gal Sn  
**Normen / standards:** DIN 46343 und ähnliche Ausführungen / *and similar types*

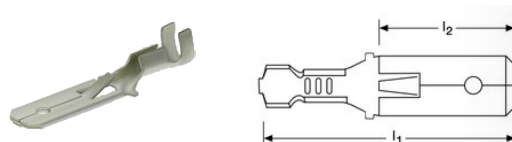

Typ <i>type</i>	Bereich mm <sup>2</sup> <i>range</i>	Steckbreite mm <i>tab-width</i>	Steckdicke mm <i>tab-thickness</i>	messungen <i>dimensions mm</i>		Gewicht/100Stk. kg <i>weight /100 pcs.</i>	VPE Stk. <i>PU</i>	ArtNr	€ /100 Stk. <i>/100 pcs.</i>
				l1	l2				
KKSE-FSRZ-1,5-2808	0,5-1,5	2,8	0,8	22,5	12,7	0,037	100	12104300152808	59,00
KKSE-FSRZ-1,5-6308		6,3	0,8	28,0	16,0	0,083		12104300156308	11,81
KKSE-FSRZ-2,5-6308	1,5-2,5	6,3	0,8	28,0	16,0	0,1	100	12104300256308	11,28
KKSE-FSRZ-6-6308	4-6	6,3	0,8	28,0	16,0	0,094	100	12104300606308	15,24

Preise gültig ab 01.01.2023 exkl. MwSt., freibleibend, Auftragsrabatt auf Anfrage /  
*prices are valid from 01.01.2023 excl. VAT, subject to change, discounts upon request*  
sonst. Konditionen siehe [www.gogatec.com/AGB.pdf](http://www.gogatec.com/AGB.pdf), techn. Änderungen vorbehalten /  
*terms & conditions can be found on our website: www.gogatec.com/AGB.pdf; error, technical modifications and variations are reserved*

Material / *material*: Messing gal verzinkt / *brass tin-plated*

Passende Werkzeuge siehe GOGATOOL Katalog / *for appropriate tools please see GOGATOOL catalog*

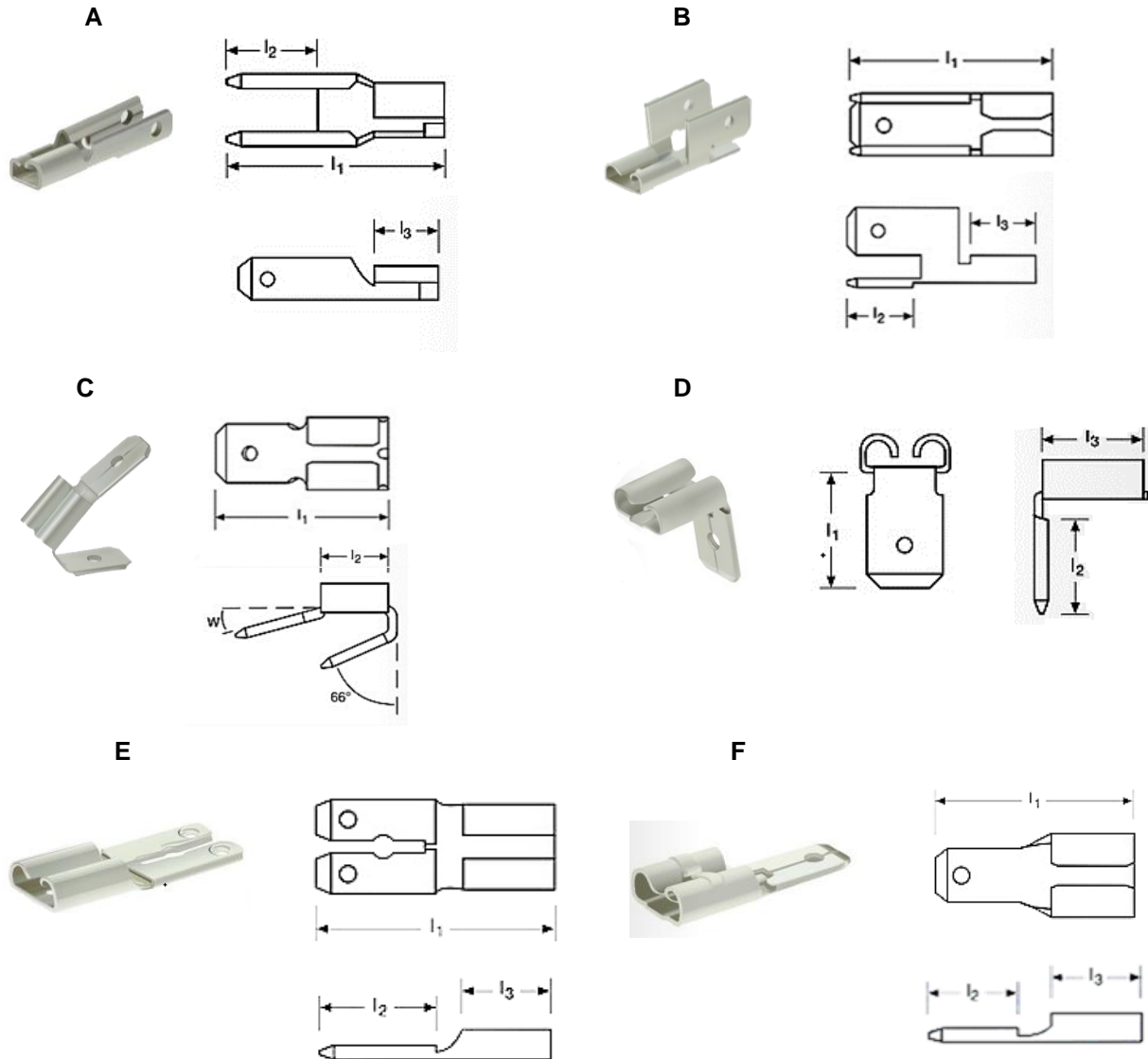

**GOGAPIN KKSE-FV Flachsteckverteiler unisoliert / *uninsulated multiple tabs***

Typ <i>type</i>	Skizze <i>drawing</i>	Steckbreite mm <i>tab-width</i>	Steckdicke mm <i>tab-thickness</i>	Abmessungen mm <i>dimensions mm</i>			Gewicht/100Stk. kg <i>weight / 100 pcs.</i>	VPE Stk. <i>PU</i>	ArtNr	€ /100 Stk. <i>/ 100 pcs.</i>
				l1	l2	l3/w				
KKSE-FV1-6308	F	6,3	0,8	18,0	8,0	7,5	0,12	100	12106116308	47,22
KKSE-FV2-2808	A	2,8	0,8	16,0	6,7	5,0	0,056	100	12106122808	22,91
KKSE-FV2-4808	E	4,8	0,8	16,0	8,0	6,3	0,056	100	12106124808	24,12
KKSE-FV2-6308	C	6,3	0,8	18,3	7,5	15°	0,114	100	12106126308	12,51
KKSE-FV3-4808	B	4,8	0,8	20,0	7	7	0,153	100	12106134808	43,44
KKSE-FV3-6308	B	6,3	0,8	21,0	7,4	7,7	0,185	100	12106136308	22,56
KKSE-FV1-90-6308	D	6,3	0,8	9,8	8	8	0,114	100	1210626308	24,71

Preise gültig ab 01.01.2023 exkl. MwSt., freibleibend, Auftragsrabatt auf Anfrage /  
*prices are valid from 01.01.2023 excl. VAT, subject to change, discounts upon request*  
 sonst. Konditionen siehe [www.gogatec.com/AGB.pdf](http://www.gogatec.com/AGB.pdf), techn. Änderungen vorbehalten /  
*terms & conditions can be found on our website: www.gogatec.com/AGB.pdf; error, technical modifications and variations are reserved*

Passende Werkzeuge siehe GOGATOOL Katalog / *for appropriate tools please see GOGATOOL catalog*

## GOGAPIN KKSE-FSF Flachstecker-Fahne unisoliert / *uninsulated male terminals*

Material / *material*: Messing gal. verzinkt / *brass tin-plated*

Normen / *standards*: DIN 46342 Teil 1 Form A und ähnliche Ausführungen / *and similar types*

Typ <i>type</i>	Loch mm <i>hole</i>	Nenngröße mm <i>nominal size</i>	Abmessungen mm <i>dimensions mm</i>			Gewicht/100Stk. kg <i>weight / 100 pcs.</i>	VPE Stk. <i>PU</i>	ArtNr	€/100 Stk. <i>/100 pcs.</i>
			l1	l2	b				
KKSE-FSF-2808-M2	M2	2,8 - 0,8	13,0	5,5	4,5	0,03	100	1210451280802	a.A.
KKSE-FSF-4808-M3	M3	4,8 - 0,8	17,5	7,0	6,5	0,06	100	1210451480803	33,53
KKSE-FSF-6308-M3	M3	6,3 - 0,8	19,0	8,0	8,0	0,086	100	1210451630803	42,53
KKSE-FSF-6308-M4	M4		19,0	8,0	8,0	0,086		1210451630804	7,81
KKSE-FSF-6308-M5	M5		19,0	8,0	8,0	0,086		1210451630805	12,94
KKSE-FSF-6308	o.Loche		19,0	8,0	8,0	0,087		12104516308	a.A.

a. A. = auf Anfrage / *upon request*

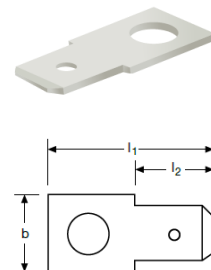

## GOGAPIN KKSE-FSF90 Flachstecker-Fahne 90° unisoliert / *uninsulated male terminals 90°*

Material / *material*: Messing gal. verzinkt / *brass tin-plated*

Normen / *standards*: DIN 46342 Teil 1 Form A und ähnliche Ausführungen / *and similar types*

Typ <i>type</i>	Loch mm <i>hole</i>	Nenngröße mm <i>nominal size</i>	Abmessungen mm <i>dimensions mm</i>			Gewicht/100Stk. kg <i>weight / 100 pcs.</i>	VPE Stk. <i>PU</i>	ArtNr	€/100 Stk. <i>/100 pcs.</i>
			l1	l2	b				
KKSE-FSF90-2808-M3	M3	2,8 - 0,8	13,0	5,5	4,5	0,03	100	1210471280803	8,57
KKSE-FSF90-4808-M3	M3	4,8 - 0,8	17,5	7,0	6,5	0,06	100	1210471480803	a.A.
KKSE-FSF90-4808-M4	M4		17,5	7,0	6,5	0,060		1210471480804	28,93
KKSE-FSF90-6308-M3	M3	6,3 - 0,8	19,0	8,0	8,0	0,085	100	1210471630803	9,65
KKSE-FSF90-6308-M4	M4		19,0	8,0	8,0	0,085		1210471630804	10,55
KKSE-FSF90-6308-M5	M5		19,0	8,0	8,0	0,085		1210471630805	38,54
KKSE-FSF90-6308	o.Loche		19,0	8,0	8,0	0,087		12104716308	a.A.

a. A. = auf Anfrage / *upon request*

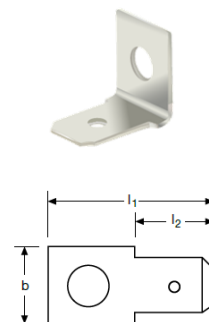

## GOGAPIN KKSE-FSF45 Flachstecker-Fahne 45° unisoliert / *uninsulated male terminals 45°*

Material / *material*: Messing gal. verzinkt / *brass tin-plated*

Typ <i>type</i>	Loch mm <i>hole</i>	Nenngröße mm <i>nominal size</i>	Abmessung mm <i>dimensions mm</i>			Gewicht/100Stk. kg <i>weight / 100 pcs.</i>	VPE Stk. <i>PU</i>	ArtNr	€/100 Stk. <i>/100 pcs.</i>
			l1	l2	b				
KKSE-FSF45-4808-M3	M3	4,8 - 0,8	17,5	7,0	6,5	0,06	100	1210461480803	16,10
KKSE-FSF45-6308-M3	M3	6,3 - 0,8	19,0	8,0	8,0	0,085	100	1210461630803	14,48
KKSE-FSF45-6308-M4	M4		19,0	8,0	8,0	0,085		1210461630804	11,01
KKSE-FSF45-6308-M5	M5		19,0	8,0	8,0	0,085		1210461630805	17,72
KKSE-FSF45-6308-M6	M6		19,0	8,0	8,0	0,085		1210461630806	13,38
KKSE-FSF45-6308	o.Loche		19,0	8,0	8,0	0,087		12104616308	a.A.

a. A. = auf Anfrage / *upon request*

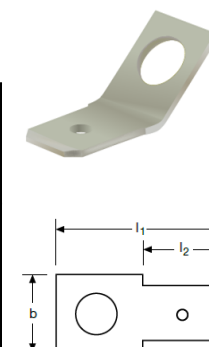

## GOGAPIN KKSE-FSF2/45 45° 2-fach unisoliert / *uninsulated male terminals double 45°*

Material / *material*: Messing gal. verzinkt / *brass tin-plated*

Typ <i>type</i>	Loch mm <i>hole</i>	Nenngröße mm <i>nominal size</i>	Abmessungen mm <i>dimensions mm</i>		Gewicht/100Stk. kg <i>weight / 100 pcs.</i>	VPE Stk. <i>PU</i>	ArtNr	€/100 Stk. <i>/100 pcs.</i>
			l1	l2				
KKSE-2FSF45-6308-M3	M3	4,8 - 0,8	9,5	8,5	0,160	100	1210462630803	42,92
KKSE-2FSF45-6308-M4	M4	6,3 - 0,8	10,0	12,0	0,160	100	1210462630804	31,61
KKSE-2FSF45-6308-M5	M5		10,0	12,0	0,160		1210462630805	24,03
KKSE-2FSF45-6308-M6	M6		10,0	12,0	0,160		1210462630806	40,15

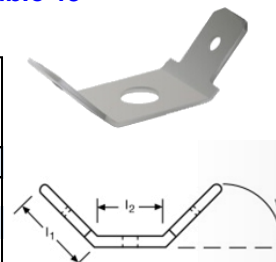

Preise gültig ab 01.01.2023 exkl. MwSt., freibleibend, Auftragsrabatt auf Anfrage /

*prices are valid from 01.01.2023 excl. VAT, subject to change, discounts upon request*

sonst. Konditionen siehe [www.gogatec.com/AGB.pdf](http://www.gogatec.com/AGB.pdf), techn. Änderungen vorbehalten /

*terms & conditions can be found on our website: www.gogatec.com/AGB.pdf; error, technical modifications and variations are reserved*

Material / *material*: Messing gal. verzinkt / *brass tin-plated*

Passende Werkzeuge siehe GOGATOOL Katalog / *for appropriate tools please see GOGATOOL catalog*

GOGAPIN KKSE-FSF345 45° 3-fach unisoliert / *uninsulated male terminals triple 45°*

Typ	Loch mm	Nenngröße mm	Messungen l1 l2		Gewicht/100Stk. kg	VPE Stk.	ArtNr	€ /100 Stk.
<i>type</i>	<i>hole</i>	<i>nominal size</i>	<i>dimensions mm</i>		<i>weight / 100 pcs.</i>	<i>PU</i>		<i>/ 100 pcs.</i>
KKSE-3FSF45-6308-M4,5	M4,6	6,3 - 0,8	12,6	8	0,241	100	1210463630804	53,40

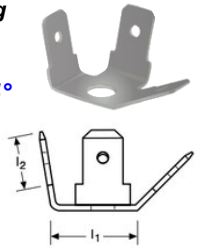

GOGAPIN KKSE-FSFR Flachstecker mit Ring abgewinkelt unisoliert / *uninsulated angled male terminals with ring*

Typ	Winkel ° w	Loch mm	Nenngröße mm	Messungen l1 l2		Gewicht/100Stk. kg	VPE Stk.	ArtNr	€ /100 Stk.
<i>type</i>	<i>angle °</i>	<i>hole</i>	<i>nominal size</i>	<i>dimensions mm</i>		<i>weight / 100 pcs.</i>	<i>PU</i>		<i>/ 100 pcs.</i>
KKSE-FSFR50-6308-M4	50°	M4	6,3 - 0,8	15,0	8,0	0,080	100	12104686308042	a.A.
KKSE-FSFR90-6308-M5	90°	M5	6,3 - 0,8	15,0	9,0	0,082	100	1210479630805	17,31
KKSE-FSFR45-6308-M6	45°	M6	6,3 - 0,8	18,5	10,0	0,170	100	1210469630806	20,06
KKSE-FSFR45-6308-M8	45°	M8	6,3 - 0,8	18,5	11,0	0,158	100	1210469630808	23,99
KKSE-FSFR45-6308-M10	45°	M10	6,3 - 0,8	18,5	12,0	0,133	100	1210469630810	29,46

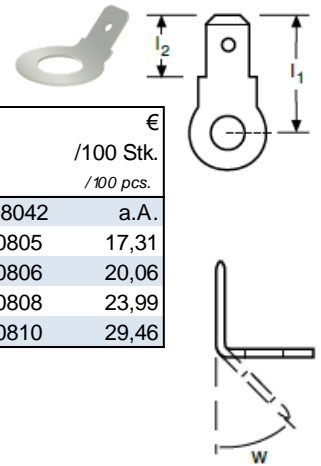

a. A. = auf Anfrage / *upon request*

GOGAPIN KKSE-FSL zum Einlöten in Platinen unisoliert / *uninsulated male terminals for soldering*

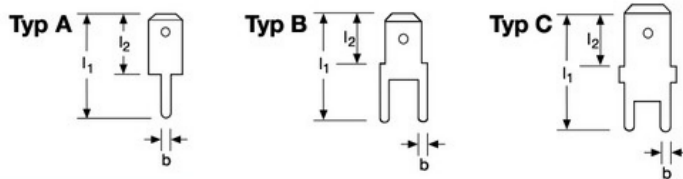

Typ	Skizze	Nenngröße mm	Abmessungen m l1 l2 b			Gewicht/100Stk. kg	VPE Stk.	ArtNr	€ /100 Stk.
<i>type</i>	<i>drawing</i>	<i>nominal size</i>	<i>dimensions mm</i>			<i>weight / 100 pcs.</i>	<i>PU</i>		<i>/ 100 pcs.</i>
KKSE-FSL-2805-10	A	2,8 - 0,5	10,5	7,0	1,3	0,05	100	121048280510	10,74
KKSE-FSL-2808-10		2,8 - 0,8	10,5	6,5	1,3	0,055	100	121048280810	18,12
KKSE-FSL-2808-14		2,8 - 0,8	14,0	6,5	1,4	0,057	100	121048280814	8,33
KKSE-FSL-4805-13	B	4,8 - 0,5	12,8	7,0	1,3	68	100	121048480513	11,13
KKSE-FSL-4808-13		4,8 - 0,8	13,5	7,0	1,2	0,07	100	121048480813	7,33
KKSE-FSL-6308-16	C	6,3 - 0,8	16,5	8,0	1,5	0,08	100	121048630816	11,80

GOGAPIN KKSE-FSL90 zum Einlöten in Platinen 90° unisoliert / *uninsulated 90° male terminals for soldering*

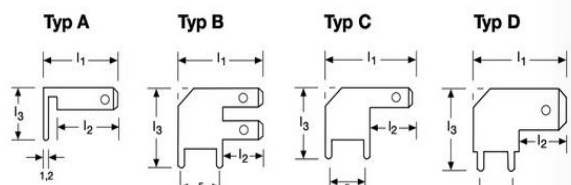

Typ	Skizze	Nenngröße mm	Abmessungen mm l1 l2 l3			Gewicht/100Stk. kg	VPE Stk.	ArtNr	€ /100 Stk.
<i>Type</i>	<i>drawing</i>	<i>nominal size</i>	<i>dimensions mm</i>			<i>weight / 100 pcs.</i>	<i>PU</i>		<i>/ 100 pcs.</i>
KKSE-FSL90-2808	A	2,8 - 0,8	12,5	11,5	7,0	0,022	100	12104912808	a.A.
KKSE-2FSL90-2808	B	2,8 - 0,8	13,5	7,0	13,0	0,075	100	12104922808	24,64
KKSE-3FSL90-2808	C	2,8 - 0,8	13,4	7,1	8,0	0,022	100	12104932808	27,53
KKSE-FSL90-4808	D	4,8 - 0,8	13,4	7,2	10,0	0,06	100	12104194808	30,58
KKSE-FSL90-6308		6,8 - 0,8	16,2	8,2	12,0	0,08	100	12104196308	18,77



Preise gültig ab 01.01.2023 exkl. MwSt., freibleibend, Auftragsrabatt auf Anfrage /

*prices are valid from 01.01.2023 excl. VAT, subject to change, discounts upon request*

sonst. Konditionen siehe [www.gogatec.com/AGB.pdf](http://www.gogatec.com/AGB.pdf), techn. Änderungen vorbehalten /

*terms & conditions can be found on our website: www.gogatec.com/AGB.pdf; error, technical modifications and variations are reserved*



Material / material: Polyamid

Farbe / colour: natur / natural

Passende Werkzeuge siehe GOGATOOL Katalog / for appropriate tools please see GOGATOOL catalog

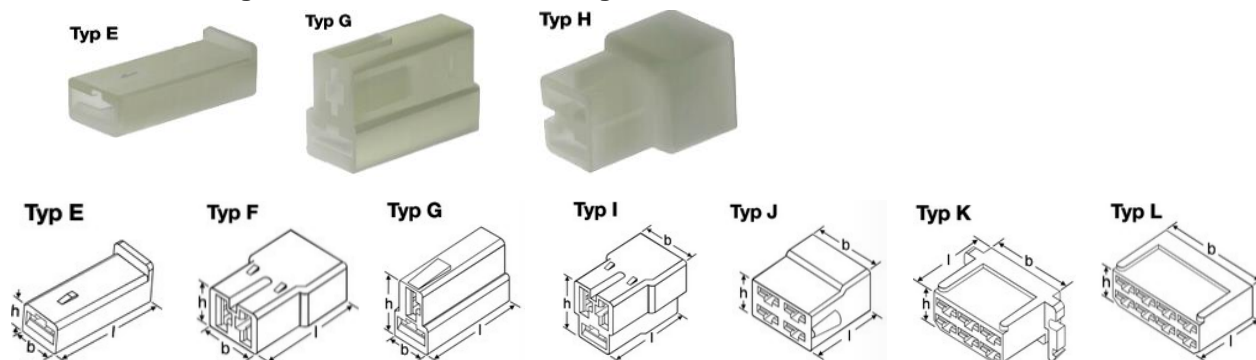

## GOGAPIN KKSE-FHG Gehäuse für Flachsteckhülsen / enclosures for female disconnects

Typ <i>type</i>	Nenngröße mm <sup>2</sup> <i>nominal size</i>	Typ <i>type</i>	Abmessungen mm <i>dimensions mm</i>			VPE Stk. <i>PU</i>	ArtNr	€/100 Stk. <i>/100 pcs.</i>
			l	h	b			
KKSE-FHG-6-6308-1	1 x 6,3	E	22,9	6,4	9,9	100	1210540063081	8,48
KKSE-FHG-6-6308-2	2 x 6,3	F	23,0	10,0	12,5	100	1210540063082	14,76
KKSE-FHG-6-6308-2.1	2 x 6,3	G	23,0	16,6	10,2	100	1210540063082.1	16,59
KKSE-FHG-6-6308-3	3 x 6,3	I	23,0	18,2	15,2	100	1210540063083	20,95
KKSE-FHG-6-6308-4	4 x 6,3	J	24,0	15,4	23,0	100	1210540063084	27,96
KKSE-FHG-6-6308-6	6 x 6,3	K	24,0	13,7	28,6	100	1210540063086	40,85
KKSE-FHG-6-6308-8	8 x 6,3	L	24,0	15,0	37,6	100	1210540063088	58,50

## GOGAPIN KKSE-FSG Gehäuse für Flachstecker / enclosures for male disconnects

Typ <i>type</i>	Nenngröße mm <sup>2</sup> <i>nominal size</i>	Typ <i>type</i>	Abmessungen mm <i>dimensions mm</i>			VPE Stk. <i>PU</i>	ArtNr	€/100 Stk. <i>/100 pcs.</i>
			l	h	b			
KKSE-FSG-6-6308-1	1 x 6,3	E	31,6	9,2	9,2	100	1210440063081	9,82
KKSE-FSG-6-6308-2	2 x 6,3	F	31,5	13,0	9,3	100	1210440063082	17,45
KKSE-FSG-6-6308-2.1	2 x 6,3	G	31,6	20,0	12,5	100	1210440063082.1	16,87
KKSE-FSG-6-6308-3	3 x 6,3	I	32,0	20,0	15,3	100	1210440063083	25,68
KKSE-FSG-6-6308-4	4 x 6,3	J	32,3	16,4	27,6	100	1210440063084	29,67
KKSE-FSG-6-6308-6	6 x 6,3	K	32,5	18,2	31,5	100	1210440063086	35,67
KKSE-FSG-6-6308-8	8 x 6,3	L	32,5	18,2	40,0	100	1210440063088	58,80

## GOGAPIN KKSE-FHIT Isoliertüllen für Flachsteckhülsen / enclosures for female disconnects

Material / material: Polyamid o. PVC

Typ <i>type</i>	Nenngröße mm <i>nominal size</i>	Abmessungen mm <i>dimensions mm</i>			VPE Stk. <i>PU</i>	ArtNr	€/100 Stk. <i>/100 pcs.</i>
		l	h	b			
KKSE-FHIT-28-PA	2,8x0,8	19,8	4,0	4,9	100	121057002808	3,93
KKSE-FHIT-28-PVC						121055002808	7,39
KKSE-FHIT-48-PA	4,8x0,8	15,8	6,0	7,6	100	121057004808	4,34
KKSE-FHIT-48-PVC						121055004808	10,19
KKSE-FHIT-63-PA	6,3x0,8	25,2	4,9	9,1	100	121057006308	3,04
KKSE-FHIT-63-PVC						121055006308	8,33
KKSE-FHIT-63-PA-V	f. verriegelbare FS-Hülse / f. lockable female disconnect				100	121057006308V	5,14
KKSE-FHIT-PA-SET	Flachsteckverbinder isoliert 2 x auf 4 x 6,3x0,8 / insulated flat plug connector 2x on 4x 6,3x0,8				100	121057006308SET	200,00



Preise gültig ab 01.01.2023 exkl. MwSt., freibleibend, Auftragsrabatt auf Anfrage /

prices are valid from 01.01.2023 excl. VAT, subject to change, discounts upon request

sonst. Konditionen siehe [www.gogatec.com/AGB.pdf](http://www.gogatec.com/AGB.pdf), techn. Änderungen vorbehalten /

terms & conditions can be found on our website: [www.gogatec.com/AGB.pdf](http://www.gogatec.com/AGB.pdf); error, technical modifications and variations are reserved