

GOGATRAY Mittenabhängung / central suspension

Passend für M8 und M10 / fits for M8 and M10

Material	Grösse	Gewicht kg/Stk.	VPE Stk.	ArtNr	€/Stk.
material	size	weight	PU		/pc.
E.G.	M8-M10	0,032	20	06-67010046	0,75
BYCRO	M8-M10	0,029	20	06-67020046	0,83
H.D.G.	M8-M10	0,031	20	06-67030046	1,18
S.S. 316	M8-M10	0,03	20	06-67060046	3,16

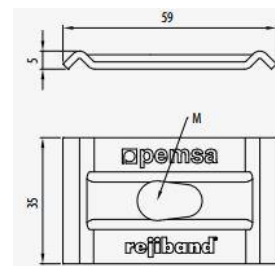

GOGATRAY Click-Mittenabhängung / click central suspension

Material	Grösse	Gewicht kg/Stk.	VPE Stk.	ArtNr	€/Stk.
material	size	weight	PU		/pc.
E.G.	M8	0,032	20	06-67010043	1,60
BYCRO	M8	0,029	20	06-67020043	1,60
H.D.G.	M8	0,031	20	06-67030043	2,89
S.S. 316	M8	0,03	20	06-67060043	3,13

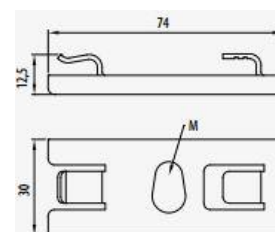

GOGATRAY Leichte Deckenbefestigung / lightweight ceiling mounting

passt für Gitterkanäle Höhe 35 & 60 mm bzw. Breite 60 & 100 & 150 mm (ausgenommen 35 x 60 mm)
fits for grid channels with 35 & 60mm (height) or 60 & 100 & 150 mm (width) (except 35 x 60 mm)

Material	Gewicht kg/Stk.	VPE Stk.	ArtNr	€/Stk.
material	weight	PU		/pc.
E.G.	0,094	36	06-62016020	4,19
BYCHRO	0,094	36	06-62026020	a.A.
H.D.G.	0,094	36	06-62036020	5,92

a. A. = auf Anfrage / upon request

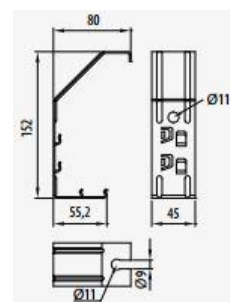
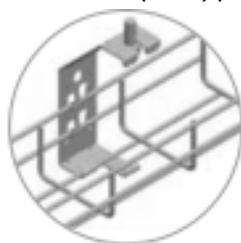

GOGATRAY Deckenbefestigung / ceiling mounting

Material	Gewicht kg/Stk.	max. Belastung (SWL) kg	VPE Stk.	ArtNr	€/Stk.
material	weight	max. load	PU		/pc.
P.G.	0,094	275	10	06-67030060	2,83

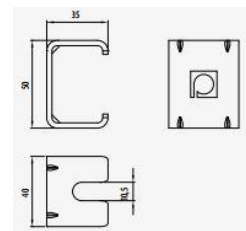

GOGATRAY Verstellbare Deckenbefestigung / adjustable ceiling mounting

Material	Gewicht kg/Stk.	max. Belastung (SWL) kg	VPE Stk.	ArtNr	€/Stk.
material	weight	max. load	PU		/pc.
H.D.G.	0,15	127	1	06-67030061	5,40

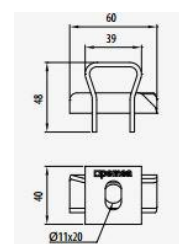

Preise gültig ab 01.01.2023 exkl. MwSt., freibleibend, Auftragsrabatt auf Anfrage /
prices are valid from 01.01.2023 excl. VAT, subject to change, discounts upon request
sonst. Konditionen siehe www.gogatec.com/AGB.pdf, techn. Änderungen vorbehalten /
terms & conditions can be found on our website: www.gogatec.com/AGB.pdf; error, technical modifications and variations are reserved

GOGATRAY Konsolenhalter OMEGA S-Plus / console holder

Material	Abmessung mm	Gewicht kg/Stk.	max. Belastung (SWL) kg	VPE Stk.	ArtNr	€ /Stk.
material	dimension	weight	max. load	PU		/pc.
P.G.	100	0,18	160	10	06-63022104	2,95
	200	0,23	160	10	06-63022204	3,98
	300	0,34	160	10	06-63022304	4,60
	400	0,43	390	10	06-63022404	5,90
	500	0,53	390	10	06-63022504	6,48
H.D.G.	600	0,63	390	10	06-63022604	8,17
	100	0,18	160	10	06-63032104	4,34
	200	0,25	160	10	06-63032204	6,55
	300	0,35	160	10	06-63032304	7,87
	400	0,45	390	10	06-63032404	9,58
	500	0,56	390	10	06-63032504	11,06
	600	0,66	390	10	06-63032604	13,62

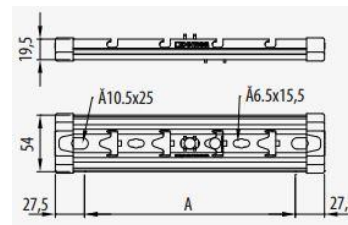
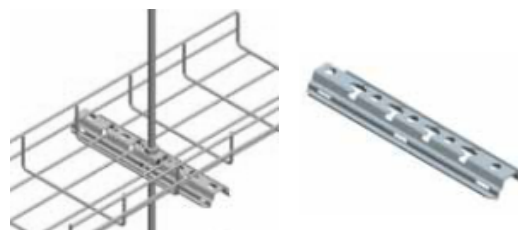

Einschließlich Sicherheitsanschlag

GOGATRAY Gewindemuffe M8 / threaded sleeve

Material	Gewicht kg/Stk.	VPE Stk.	ArtNr	€ /Stk.
material	weight	PU		/pc.
BYCRO	0,016	50	06-67020067	1,48

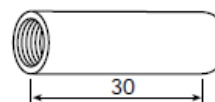

GOGATRAY Gewindestange M6/M8/M10 / threaded rod

Material	Abmessungen mm	Gewicht kg/Stk.	VPE Stk.	ArtNr	€ /Stk.
material	dimensions	weight	PU		/pc.
E.G.	M6x500	0,12	50	06-67010140	2,27
	M6x1000	0,24	50	06-67010141	2,27
BYCRO	M6x500	0,12	50	06-67020140	a.A.
	M6x1000	0,24	50	06-67020141	a.A.
	M8x500	0,16	50	06-67020044	2,51
	M8x1000	0,32	50	06-67020045	3,45
	M10x1000	0,49	50	06-67020145	6,55
S.S. 316	M6x1000	0,24	50	06-67060141	24,03
	M8x500	0,16	50	06-67060044	21,58
	M8x1000	0,32	50	06-67060045	26,15
	M10x1000	0,49	50	06-67060145	31,90

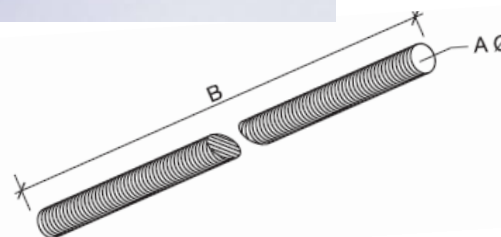

a. A. = auf Anfrage / upon request

**Materialien und Korrosionsbeständigkeit (nach BS-EN 61537):
Materials and corrosion resistance (according to BS EN 61537):**

Material	Materialbezeichnung	Beständig/h
material	material	resistant/h
P.G.	Sendzimirgalvanisiert nach / sendzimir galvanized to UNE EN 10346	190
H.D.G.	Feuerverzinkt nach / hot-dip galvanized to BS-EN ISO 10346	660
S.S. 304	Edelstahl / stainless steel AISI 304	>850
S.S. 316	Edelstahl / stainless steel AISI 316	>850

Preise gültig ab 01.01.2023 exkl. MwSt., freibleibend, Auftragsrabatt auf Anfrage /
prices are valid from 01.01.2023 excl. VAT, subject to change, discounts upon request
sonst. Konditionen siehe www.gogatec.com/AGB.pdf, techn. Änderungen vorbehalten /
terms & conditions can be found on our website: www.gogatec.com/AGB.pdf; error, technical modifications and variations are reserved

GOGATRAY E90-R-PLUS Verbinder / connector

Für E90 Installation mit OMEGA R-PLUS Konsole / for E90 mounting with OMEGA R-PLUS console

Material	Gewicht kg/Stk.	VPE Stk.	ArtNr	€/Stk.
material	weight	PU		/pc.
H.D.G.	0,15	15	06-62035001	3,57

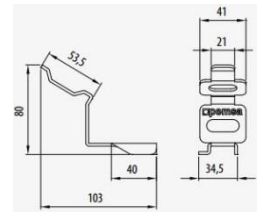

GOGATRAY E90-S-PLUS Verbinder / connector

Für E90 Installation mit S-PLUS Konsole / for E90 mounting with S-PLUS console

Material	Gewicht kg/Stk.	VPE Stk.	ArtNr	€/Stk.
material	weight	PU		/pc.
H.D.G.	0,15	60	06-62031090	3,25

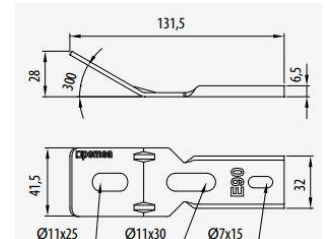
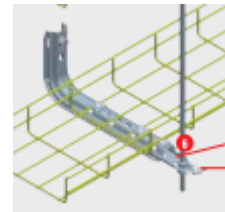

GOGATRAY Trägerklammer / beam clamp

Material	Gewicht kg/Stk.	VPE Stk.	ArtNr	€/Stk.
material	weight	PU		/pc.
BYCRO	0,34	1	06-67020048	10,53

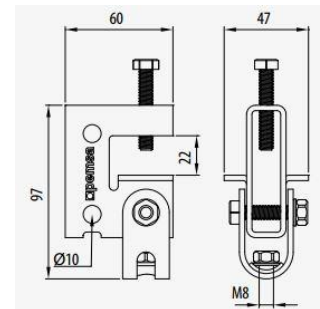
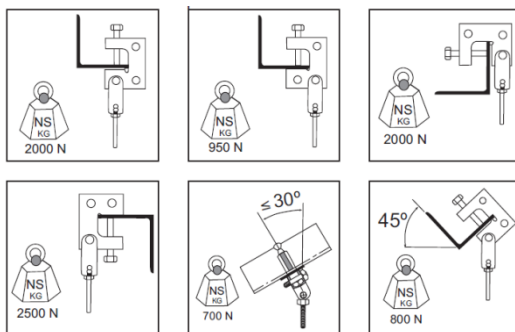

GOGATRAY Waagrechte Aufhängungshalterung / horizontal mount bracket

Material	Abmessung mm	Gewicht kg/Stk.	max. Belastung (SWL) kg	VPE Stk.	ArtNr	€/Stk.
material	dimension	weight	max. load	PU		/pc.
Passiviert / passivated	1,5-5	0,05	65	100	06-68000721	2,72
	4,0-10	0,05	65	100	06-68000722	3,34

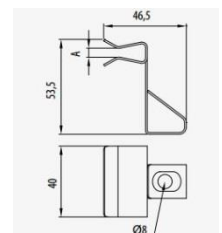

GOGATRAY Senkrechte Aufhängungshalterung / vertical mount bracket

Material	Abmessung mm	Gewicht kg/Stk.	max. Belastung (SWL) kg	VPE Stk.	ArtNr	€/Stk.
material	dimension	weight	max. load	PU		/pc.
Passiviert / passivated	1,5-5	0,04	65	100	06-68000731	3,01
	4,0-10	0,04	65	100	06-68000732	3,01

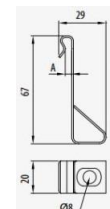

Materialien und Korrosionsbeständigkeit (nach BS-EN 61537):

Materials and corrosion resistance (according to BS EN 61537):

Material	Materialbezeichnung	Beständig/h
material	material	resistant/h
P.G.	Sendzimirgalvanisiert nach / sendzimir galvanized to UNE EN 10346	190
H.D.G.	Feuerverzinkt nach / hot-dip galvanized to BS-EN ISO 10346	660
S.S. 304	Edelstahl / stainless steel AISI 304	>850
S.S. 316	Edelstahl / stainless steel AISI 316	>850

Preise gültig ab 01.01.2023 exkl. MwSt., freibleibend, Auftragsrabatt auf Anfrage /

prices are valid from 01.01.2023 excl. VAT, subject to change, discounts upon request

sonst. Konditionen siehe www.gogatec.com/AGB.pdf, techn. Änderungen vorbehalten /

terms & conditions can be found on our website: www.gogatec.com/AGB.pdf; error, technical modifications and variations are reserved

GOGATRAY Deckenkonsole Omega S-Plus / overhead console

Material	Abmessung mm	Gewicht kg/Stk.	max. Belastung (SWL) kg	VPE Stk.	ArtNr	€ /Stk.
material	dimension	weight	max. load	PU		/pc.
P.G.	100	0,42	33	4	06-62022104	5,86
	150	0,62	36	4	06-62022154	6,91
	200	0,67	29	4	06-62022204	7,67
	300	0,82	25	4	06-62022304	8,40
	400	0,94	18	4	06-62022404	10,38
H.D.G.	100	0,44	33	4	06-62032104	8,40
	150	0,66	36	4	06-62032154	11,68
	200	0,72	29	4	06-62032204	13,39
	300	0,86	25	4	06-62032304	15,07
	400	0,99	18	4	06-62032404	17,07
S.S. 304	100	0,56	33	4	06-62052104	27,71
	150	0,62	36	4	06-62052154	29,71
	200	0,69	29	4	06-62052204	35,17
	300	0,82	25	4	06-62052304	39,71
	400	0,94	18	4	06-62052404	41,00
S.S. 316	100	0,56	33	4	06-62062104	a.A.
	150	0,62	36	4	06-62062154	a.A.
	200	0,69	29	4	06-62062204	a.A.
	300	0,82	25	4	06-62062304	a.A.
	400	0,94	18	4	06-62062404	a.A.

a. A. = auf Anfrage / upon request

Einschließlich Sicherheitsanschlag

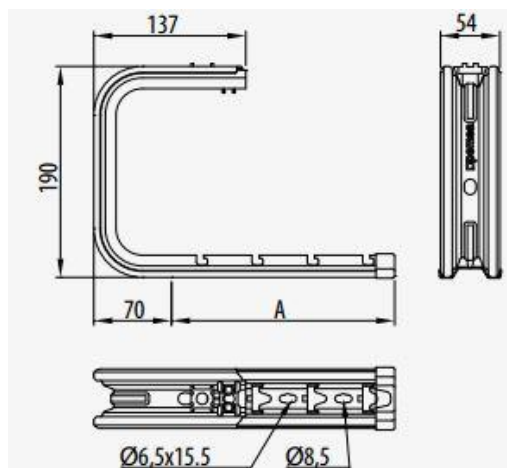

GOGATRAY Profil Omega S-Plus / channel

**Zum Konfektionieren vor Ort und für mehrreihige Montagen
for terminating on site and for multi-row assemblies**

Material	Länge m	Gewicht kg/Stk.	VPE Stk.	ArtNr	€ /Stk.
material	dimension	weight	PU		/pc.
P.G.	1	1,2	1	06-67020110	14,71
	2	2,4	1	06-67020111	33,37
	3	3,6	1	06-67020112	49,73
H.D.G.	1	1,3	1	06-67030110	19,63
	2	2,6	1	06-67030111	54,50
	3	3,9	1	06-67030112	81,40

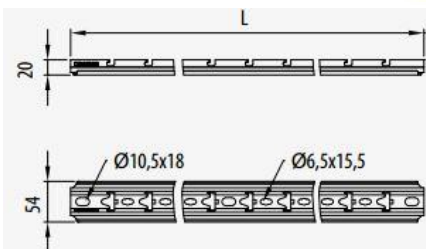

Materialien und Korrosionsbeständigkeit (nach BS-EN 61537):

Materials and corrosion resistance (according to BS EN 61537):

Material	Materialbezeichnung	Beständig/h
material	material	resistant/h
P.G.	Sendzimirgalvanisiert nach / sendzimir galvanized to UNE EN 10346	190
H.D.G.	Feuerverzinkt nach / hot-dip galvanized to BS-EN ISO 10346	660
S.S. 304	Edelstahl / stainless steel AISI 304	>850
S.S. 316	Edelstahl / stainless steel AISI 316	>850

Preise gültig ab 01.01.2023 exkl. MwSt., freibleibend, Auftragsrabatt auf Anfrage /

prices are valid from 01.01.2023 excl. VAT, subject to change, discounts upon request

sonst. Konditionen siehe www.gogatec.com/AGB.pdf, techn. Änderungen vorbehalten /

terms & conditions can be found on our website: www.gogatec.com/AGB.pdf; error, technical modifications and variations are reserved

GOGATRAY Verstärkter Hängestiel 41x41 / reinforced suspended support

Material	Abmessung mm	Gewicht kg/Stk.	VPE Stk.	ArtNr	€/Stk.
material	dimension	weight	PU		/pc.
H.D.G.	500	1,51	1	06-67030660	25,44
	1000	2,47	1	06-67030661	41,89

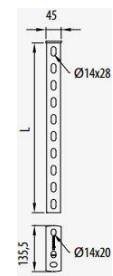

GOGATRAY Doppelter Verstärkter Hängestiel 41x41 / double reinforced suspended support

Material	Abmessung mm	Gewicht kg/Stk.	VPE Stk.	ArtNr	€/Stk.
material	dimension	weight	PU		/pc.
H.D.G.	500	2,48	1	06-67030662	46,96
	1000	4,4	1	06-67030663	82,20

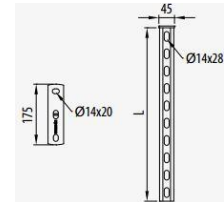

GOGATRAY Verstärkte Pendelschiene / reinforced swing rail

Material	Abmessung mm	Gewicht kg/Stk.	VPE Stk.	ArtNr	€/Stk.
material	dimension	weight	PU		/pc.
P.G.	500	0,87	1	06-67030646	a.A.
	1000	1,76	1	06-67030647	a.A.

a. A. = auf Anfrage / upon request

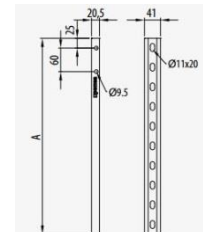
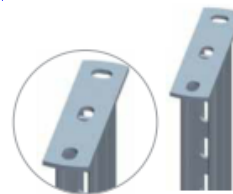

GOGATRAY Verstärkter Pendelaufhängung / reinforced pendulum suspension

Material	Gewicht kg/Stk.	VPE Stk.	ArtNr	€/Stk.
material	weight	PU		/pc.
P.G.	0,57	1	06-67030645	a.A.

a. A. = auf Anfrage / upon request

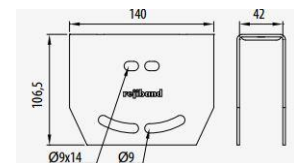

GOGATRAY Winkelbefestigung / angle attachment

Material	Gewicht kg/Stk.	VPE Stk.	ArtNr	€/Stk.
material	weight	PU		/pc.
E.B.	0,18	10	06-67020051	5,84

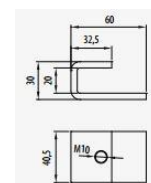

**Materialien und Korrosionsbeständigkeit (nach BS-EN 61537):
Materials and corrosion resistance (according to BS EN 61537):**

Material	Materialbezeichnung	Beständig/h
material	material	resistant/h
P.G.	Sendzimirgalvanisiert nach / sendzimir galvanized to UNE EN 10346	190
H.D.G.	Feuerverzinkt nach / hot-dip galvanized to BS-EN ISO 10346	660
S.S. 304	Edelstahl / stainless steel AISI 304	>850
S.S. 316	Edelstahl / stainless steel AISI 316	>850

Preise gültig ab 01.01.2023 exkl. MwSt., freibleibend, Auftragsrabatt auf Anfrage /
prices are valid from 01.01.2023 excl. VAT, subject to change, discounts upon request
sonst. Konditionen siehe www.gogatec.com/AGB.pdf, techn. Änderungen vorbehalten /
terms & conditions can be found on our website: www.gogatec.com/AGB.pdf; error, technical modifications and variations are reserved